

Approval body for construction products  
and types of construction

Bautechnisches Prüfamt

An institution established by the Federal and  
Laender Governments



## European Technical Assessment

**ETA-16/0089**  
**of 24 November 2016**

English translation prepared by DIBt - Original version in German language

### General Part

Technical Assessment Body issuing the  
European Technical Assessment:

Deutsches Institut für Bautechnik

Trade name of the construction product

EJOT Chemical Anchor MULTIFIX USF  
or MULTIFIX USF winter for masonry

Product family  
to which the construction product belongs

Injection system for use in masonry

Manufacturer

EJOT Baubefestigungen GmbH  
In der Stockwiese 35  
57334 Bad Laasphe  
DEUTSCHLAND

Manufacturing plant

EJOT Herstellwerk 24

This European Technical Assessment  
contains

61 pages including 3 annexes which form an integral part  
of this assessment

This European Technical Assessment is  
issued in accordance with Regulation (EU)  
No 305/2011, on the basis of

Guideline for European technical approval of "Metal  
Injection Anchors for Use in Masonry", ETAG 029, April  
2013,  
used as European Assessment Document (EAD)  
according to Article 66 Paragraph 3 of Regulation (EU)  
No 305/2011.

The European Technical Assessment is issued by the Technical Assessment Body in its official language. Translations of this European Technical Assessment in other languages shall fully correspond to the original issued document and shall be identified as such.

Communication of this European Technical Assessment, including transmission by electronic means, shall be in full. However, partial reproduction may only be made with the written consent of the issuing Technical Assessment Body. Any partial reproduction shall be identified as such.

This European Technical Assessment may be withdrawn by the issuing Technical Assessment Body, in particular pursuant to information by the Commission in accordance with Article 25(3) of Regulation (EU) No 305/2011.

**Specific Part**

**1 Technical description of the product**

The EJOT Chemical Anchor MULTIFIX USF or MUTLIFIX USF winter for masonry is a bonded anchor (injection type) consisting of a mortar cartridge with injection mortar MUTLIFIX USF or MUTLIFIX USF winter, a perforated sleeve and an anchor rod with hexagon nut and washer. The steel elements are made of zinc coated steel or stainless steel.

The anchor rod is placed into a drilled hole filled with injection mortar and is anchored via the bond between steel element, injection mortar and masonry and mechanical interlock.

The Illustration and the description of the product are given in Annex A.

**2 Specification of the intended use in accordance with the applicable European Assessment Document**

The performances given in Section 3 are only valid if the anchor is used in compliance with the specifications and conditions given in Annex B.

The verifications and assessment methods on which this European Technical Assessment is based lead to the assumption of a working life of the anchor of at least 50 years. The indications given on the working life cannot be interpreted as a guarantee given by the producer, but are to be regarded only as a means for choosing the right products in relation to the expected economically reasonable working life of the works.

**3 Performance of the product and references to the methods used for its assessment**

**3.1 Mechanical resistance and stability (BWR 1)**

Essential characteristic	Performance
Characteristic resistance for steel elements	See Annex C2
Characteristic resistance for anchors in masonry units	See Annex C3 – C45
Displacements under shear and tension loads	See Annex C4 – C45
Reduction Factor for job site tests ( $\beta$ -Factor)	See Annex C1
Edge distances and spacing	See Annex C3 – C45
Group factor for group fastenings	See Annex C3 – C45

**3.2 Safety in case of fire (BWR 2)**

Essential characteristic	Performance
Reaction to fire	Class A1
Resistance to fire	No performance assessed

**3.3 Hygiene, health and the environment (BWR 3)**

Regarding dangerous substances there may be requirements (e.g. transposed European legislation and national laws, regulations and administrative provisions) applicable to the products falling within the scope of this European Technical Assessment. In order to meet the provisions of Regulation (EU) No 305/2011, these requirements need also to be complied with, when and where they apply.

English translation prepared by DIBt

**3.4 Safety in use (BWR 4)**

The essential characteristics regarding Safety in use are included under the Basic Works Requirement Mechanical resistance and stability.

**4 Assessment and verification of constancy of performance (AVCP) system applied, with reference to its legal base**

In accordance with guideline for European technical approval ETAG 029, April 2013 used as European Assessment Document (EAD) according to Article 66 Paragraph 3 of Regulation (EU) No 305/2011 the applicable European legal act is: [97/177/EC].

The system to be applied is: 1

**5 Technical details necessary for the implementation of the AVCP system, as provided for in the applicable European Assessment Document**

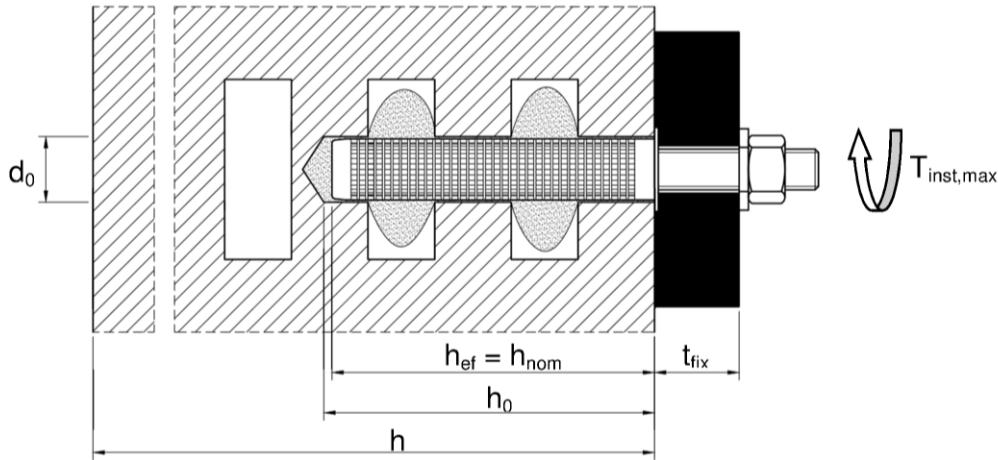
Technical details necessary for the implementation of the AVCP system are laid down in the control plan deposited at Deutsches Institut für Bautechnik.

Issued in Berlin on 24 November 2016 by Deutsches Institut für Bautechnik

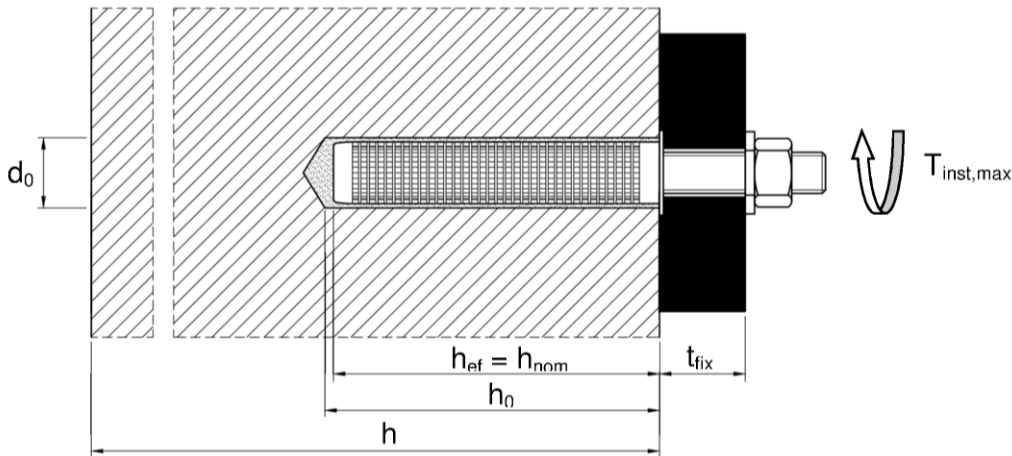
Uwe Bender  
Head of Department

*beglaubigt:*  
Baderschneider

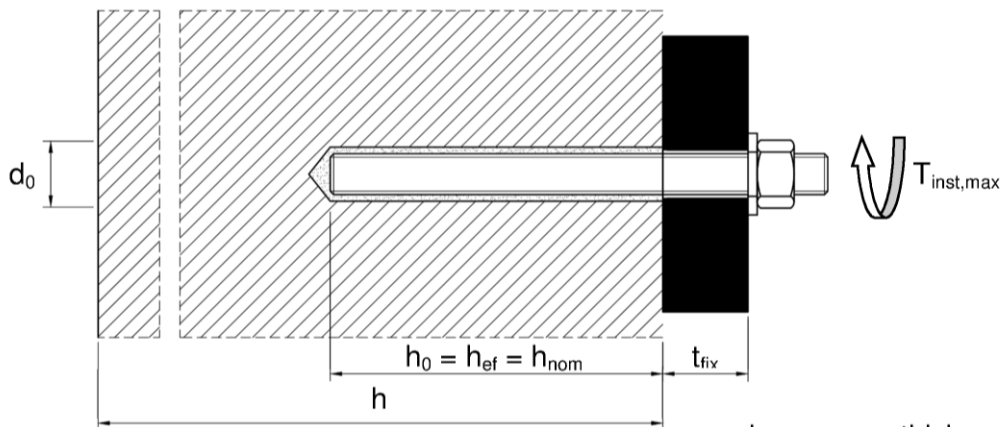
**Installation in hollow brick; threaded rod and Internal threaded rod with sleeve**



**Installation in solid brick; threaded rod and Internal threaded rod with sleeve**



**Installation in solid brick; threaded rod and Internal threaded rod without sleeve**



$d_0$  = nominal drill hole diameter  
 $t_{fix}$  = thickness of fixture  
 $T_{inst,max}$  = max installation torque moment

$h$  = thickness of member  
 $h_0$  = depth of drill hole depth at shoulder  
 $h_{ef}$  = effective anchorage depth  
 $h_{nom}$  = overall embedment depth

**EJOT Chemical Anchor MULTIFIX USF or MULTIFIX USF winter for masonry**

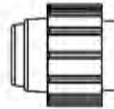
**Product description**  
Installed condition

**Annex A 1**

**Cartridge: MULTIFIX USF or MULTIFIX USF winter**

**150 ml, 280 ml, 300 ml up to 333 ml and 380 ml up to 420 ml cartridge (Type: coaxial)**

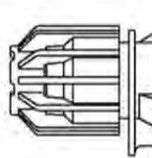
Sealing/Screw cap



Imprint: MULTIFIX USF or MULTIFIX USF winter processing notes, charge-code, shelf life, hazard-code, curing- and processing time (depending on the temperature), optional with travel scale

**235 ml, 345 ml up to 360 ml and 825 ml cartridge (Type: "side-by-side")**

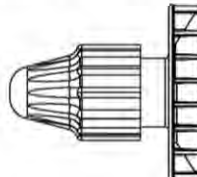
Sealing/Screw cap



Imprint: MULTIFIX USF or MULTIFIX USF winter, processing notes, charge-code, shelf life, hazard-code, curing- and processing time (depending on the temperature), optional with travel scale

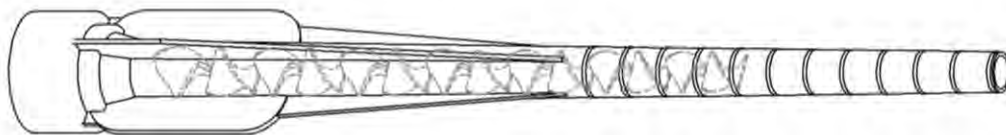
**165 ml and 300 ml cartridge (Type: "foil tube")**

Sealing/Screw cap



Imprint: MULTIFIX USF or MULTIFIX USF winter processing notes, charge-code, shelf life, hazard-code, curing- and processing time (depending on the temperature), optional with travel scale

**Static Mixer**

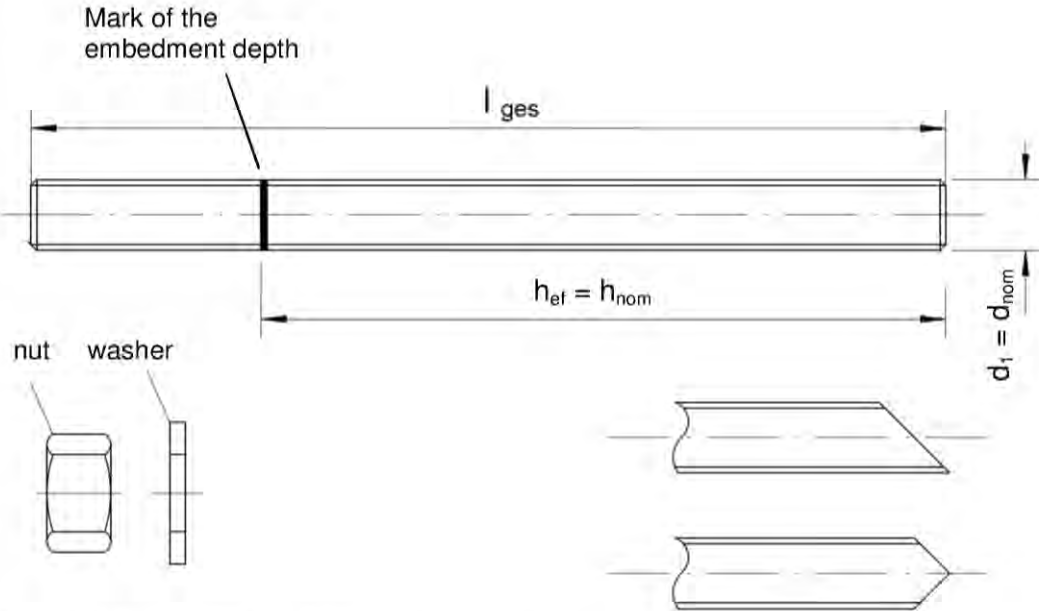


**EJOT Chemical Anchor MULTIFIX USF or MULTIFIX USF winter for masonry**

**Product description**  
Injection system

**Annex A 2**

### Threaded rod M8, M10, M12, M16

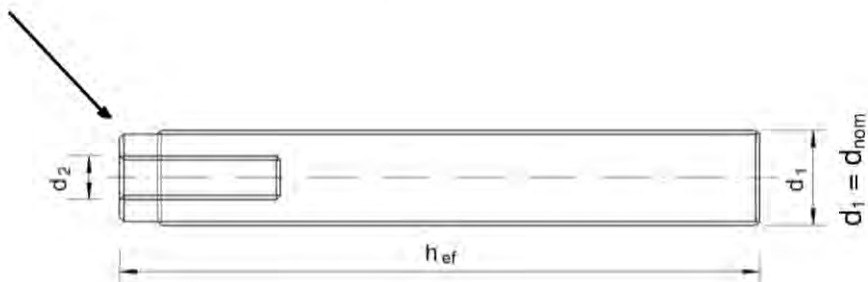



Commercial standard rod with:

- Materials, dimensions and mechanical properties acc. to Table A1
- Inspection certificate 3.1 acc. to EN 10204:2004. The document shall be stored.
- Marking of embedment depth

### Internal threaded rod IG-M6, IG-M8, IG-M10

Mark the producer



Marking: e.g.  M8

EJOT Chemical Anchor MULTIFIX USF or MULTIFIX USF winter for masonry

Product description  
Anchor rods

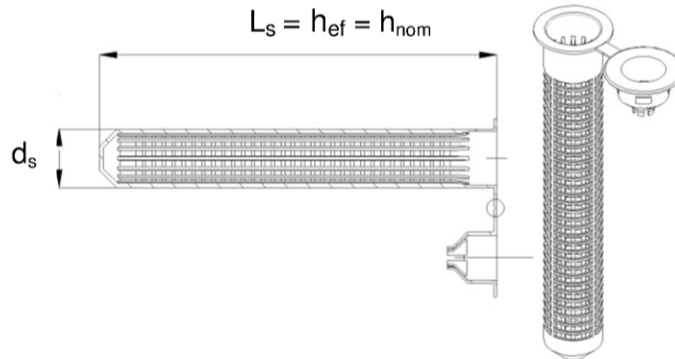
Annex A 3

<b>Table A1: Materials</b>	
<b>Designation</b>	<b>Material</b>
<b>Steel, zinc plated <math>\geq 5 \mu\text{m}</math> acc. to EN ISO 4042:1999 or Steel, hot-dip galvanised <math>\geq 40 \mu\text{m}</math> acc. to EN ISO 1461:2009 and EN ISO 10684:2004+AC:2009</b>	
Anchor rod	Steel, EN 10087:1998 or EN 10263:2001 Property class 4.6, 4.8, 5.6, 5.8, 8.8 acc. EN 1993-1-8:2005+AC:2009 $A_s > 8\%$ fracture elongation
Hexagon nut, EN ISO 4032:2012	Steel acc. EN 10087:1998 or EN 10263:2001 Property class 4 (for class 4.6, 4.8 rod) EN ISO 898-2:2012 Property class 5 (for class 5.6, 5.8 rod) EN ISO 898-2:2012 Property class 8 (for class 8.8 rod) EN ISO 898-2:2012
Washer, EN ISO 887:2006, EN ISO 7089:2000, EN ISO 7093:2000, or EN ISO 7094:2000	Steel, zinc plated or hot-dip galvanised
Internal threaded rod	Steel, zinc plated Property class 5.6, 5.8 and 8.8 EN ISO 898-1:2013
<b>Stainless steel</b>	
Anchor rod	Material 1.4401 / 1.4404 / 1.4571, EN 10088-1:2014, Property class 70 EN ISO 3506-1:2009 Property class 80 EN ISO 3506-1:2009
Hexagon nut, EN ISO 4032:2012	Material 1.4401 / 1.4404 / 1.4571 EN 10088-1:2014, Property class 70 (for class 70 rod) EN ISO 3506-2:2009 Property class 80 (for class 80 rod) EN ISO 3506-2:2009
Washer, EN ISO 887:2006, EN ISO 7089:2000, EN ISO 7093:2000, or EN ISO 7094:2000	Material 1.4401, 1.4404 or 1.4571, EN 10088-1:2014
Internal threaded rod	Stainless steel: 1.4401 / 1.4404 / 1.4571, EN 10088-1:2014 Property class 70 (for class 70 rod) EN ISO 3506-1:2009
<b>High corrosion resistant steel (HCR)</b>	
Anchor rod	Material 1.4529 / 1.4565, EN 10088-1:2014, Property class 70 EN ISO 3506-1:2009 Property class 80 EN ISO 3506-1:2009
Hexagon nut, EN ISO 4032:2012	Material 1.4529 / 1.4565, EN 10088-1:2014, Property class 70 (for class 70 rod) EN ISO 3506-2:2009 Property class 80 (for class 80 rod) EN ISO 3506-2:2009
Washer, EN ISO 887:2006, EN ISO 7089:2000, EN ISO 7093:2000, or EN ISO 7094:2000	Material 1.4529 / 1.4565, EN 10088-1:2014
Internal threaded rod	Stainless steel: 1.4529 / 1.4565, EN 10088-1:2014 Property class 70 (for class 70 rod) EN ISO 3506-1:2009
<b>Plastic sleeve</b>	
Perforated sleeve	Material: Polypropylene
<b>EJOT Chemical Anchor MULTIFIX USF or MULTIFIX USF winter for masonry</b>	<b>Annex A 4</b>
<b>Product description</b> Materials	

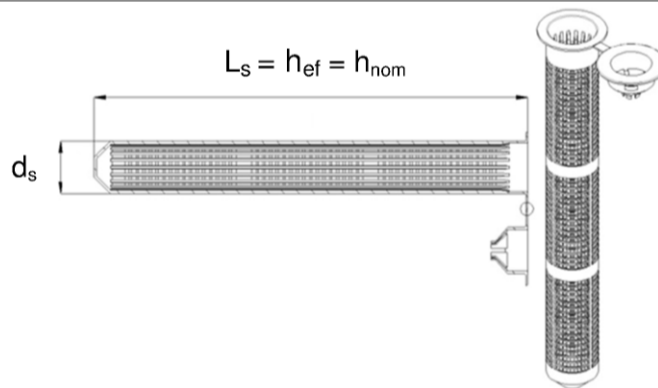


**Table A2: Sleeve (Plastic)**

SH 12x80  
SH 16x85  
SH 20x85



SH 16x130  
SH 20x130  
SH 20x200



**Table A3: Sizes sleeve**

Sleeve		12x80	16x85	16x130	20x85	20x130	20x200
Diameter of sleeve	$d_s = d_{nom}$ [mm]	12	16	16	20	20	20
Length of sleeve	$L_s$ [mm]	80	85	130	85	130	200
Effective anchorage depth	$h_{ef}$ [mm]	80	85	130	85	130	200
Overall anchor embedment	$h_{nom}$ [mm]	80	85	130	85	130	200

**Table A4: Steel**

Anchor rod		IG-M6	IG-M8	IG-M10	M8	M10	M12	M16
Outside diameter of anchor	$d_1 = d_{nom}$ [mm]	10 <sup>1)</sup>	12 <sup>1)</sup>	16 <sup>1)</sup>	8	10	12	16
Diameter of internal thread	$d_2$ [mm]	6	8	10	-	-	-	-
Thread engagement length Min/max	$l_{IG}$ [mm]	8/20	8/20	10/25	-	-	-	-
Total length of steel element	$l_{ges}$ [mm]	With sleeve: $h_{ef} - 5\text{mm}$ Without sleeve: $h_{ef}$			$h_{ef} + t_{fix} + 9,5$	$h_{ef} + t_{fix} + 11,5$	$h_{ef} + t_{fix} + 17,5$	$h_{ef} + t_{fix} + 20,0$

<sup>1)</sup> Internal threaded rod with metric external thread

**EJOT Chemical Anchor MULTIFIX USF or MULTIFIX USF winter for masonry**

**Product description**  
Sleeves

**Annex A 5**

### Specifications of intended use

#### Anchorage subject to:

- Static and quasi-static loads

#### Base materials:

- Autoclaved Aerated Concrete (Use category d) according to Annex B2
- Solid brick masonry (Use category b), according to Annex B2.
- Hollow brick masonry (use category c), according to Annex B2 and B3
- Mortar strength class of the masonry M2,5 at minimum according to EN 998-2:2010.
- For other bricks in solid masonry and in hollow or perforated masonry, the characteristic resistance of the anchor may be determined by job site tests according to ETAG 029, Annex B under consideration of the  $\beta$ -factor according to Annex C1, Table C1.

Note: The characteristic resistance for solid bricks and autoclaved aerated concrete are also valid for larger brick sizes and larger compressive strength of the masonry unit.

#### Temperature Range:

- $T_a$ : - 40°C to +40°C (max. short term temperature +40°C and max. long term temperature +24°C)
- $T_b$ : - 40°C to +80°C (max. short term temperature +80°C and max. long term temperature +50°C)
- $T_c$ : - 40°C to +120°C (max. short term temperature +120°C and max. long term temperature +72°C)

#### Use conditions (Environmental conditions):

- Dry and wet structure (regarding injection mortar).
- Structures subject to dry internal conditions (zinc coated steel, stainless steel or high corrosion resistant steel).
- Structures subject to external atmospheric exposure (including industrial and marine environment) and to permanently damp internal condition, if no particular aggressive conditions exist (stainless steel or high corrosion resistant steel).
- Structures subject to external atmospheric exposure and to permanently damp internal condition, if other particular aggressive conditions exist (high corrosion resistant steel).

Note: Particular aggressive conditions are e.g. permanent, alternating immersion in seawater or the splash zone of seawater, chloride atmosphere of indoor swimming pools or atmosphere with extreme chemical pollution (e.g. in desulphurization plants or road tunnels where de-icing materials are used).

#### Use categories in respect of installation and use:

- Category d/d: Installation and use in dry masonry
- Category w/w: Installation and use in dry or wet masonry (incl. w/d installation in wet masonry and use in dry masonry)

#### Design:

- Verifiable calculation notes and drawings are prepared taking account the relevant masonry in the region of the anchorage, the loads to be transmitted and their transmission to the supports of the structure. The position of the anchor is indicated on the design drawings.
- The anchorages are designed in accordance with the ETAG 029, Annex C, Design method A under the responsibility of an engineer experienced in anchorages and masonry work.
- $N_{Rk,p} = N_{Rk,b}$  see Annex C4 to C45;  $N_{Rk,s}$  see Annex C3;  $N_{Rk,pb}$  see ETAG 029, Annex C
- $V_{Rk,b}$  and  $V_{Rk,c}$  see Annex C4 to C45;  $V_{Rk,s}$  see Annex C3;  $V_{Rk,pb}$  see ETAG 029, Annex C
- For application with sleeve with drill bit size  $\leq 15$ mm installed in joints not filled with mortar:
  - $N_{Rk,p,j} = 0,18 * N_{Rk,p}$  and  $N_{Rk,b,j} = 0,18 * N_{Rk,b}$  ( $N_{Rk,p} = N_{Rk,b}$  see Annex C4 to C45)
  - $V_{Rk,c,j} = 0,15 * V_{Rk,c}$  and  $V_{Rk,b,j} = 0,15 * V_{Rk,b}$  ( $V_{Rk,b}$  and  $V_{Rk,c}$  see Annex C4 to C45)
- Application without sleeve installed in joints not filled with mortar is not allowed.

#### Installation:









- Dry or wet structures.
- Anchor Installation carried out by appropriately qualified personnel and under the supervision of the person responsible for technical matters of the site.
- Fastening screws or threaded rods (incl. nut and washer) must comply with the appropriate material and property class of the Internal threaded rod .

**EJOT Chemical Anchor MULTIFIX USF or MULTIFIX USF winter for masonry**

**Intended Use Specifications**

**Annex B 1**

<b>Table B1: Overview brick types and properties with corresponding fastening elements (Anchor and Sleeves)</b>							
Brick-No.	Brick type	Picture	Brick size	Compressive strength	Bulk density	Sleeve - Anchor type	Annex
			length width height				
<b>Autoclaved aerated concrete units according EN 771-4</b>							
1	Autoclaved Aerated Concrete AAC6		499 240 249	6	0,6	M8/M10/M12/M16/IG-M6/IG-M8/IG-M10	C4 – C5
<b>Calcium silicate masonry units according EN 771-2</b>							
2	Calcium silicate solid brick KS-NF		240 115 71	10 20 27	2,0	M8/M10/M12/M16/IG-M6/IG-M8/IG-M10 SH 12x80 – M8 SH 16x85 – M8/M10/IG-M6 SH 16x130 – M8/M10/IG-M6 SH 20x85 – M12/M16/IG-M8/IG-M10 SH 20x130 – M12/M16/IG-M8/IG-M10 SH 20x200 – M12/M16/IG-M8/IG-M10	C6 – C8
3	Calcium silicate hollow brick KSL-3DF		240 175 113	8 12 14	1,4	SH 12x80 – M8 SH 16x85 – M8/M10/IG-M6 SH 16x130 – M8/M10/IG-M6 SH 20x85 – M12/M16/IG-M8/IG-M10 SH 20x130 – M12/M16/IG-M8/IG-M10 SH 20x200 – M12/M16/IG-M8/IG-M10	C9 - C11
4	Calcium silicate hollow brick KSL-12DF		498 175 238	10 12 16	1,4	SH 12x80 – M8 SH 16x85 – M8/M10/IG-M6 SH 16x130 – M8/M10/IG-M6 SH 20x85 – M12/M16/IG-M8/IG-M10 SH 20x130 – M12/M16/IG-M8/IG-M10	C12 - C14
<b>Clay masonry units according EN 771-1</b>							
5	Clay solid brick Mz – DF		240 115 55	10 20 28	1,6	M8/M10/M12/M16/IG-M6/IG-M8/IG-M10 SH 12x80 – M8 SH 16x85 – M8/M10/IG-M6 SH 16x130 – M8/M10/IG-M6 SH 20x85 – M12/M16/IG-M8/IG-M10 SH 20x130 – M12/M16/IG-M8/IG-M10 SH 20x200 – M12/M16/IG-M8/IG-M10	C15 - C17
6	Clay hollow brick Hz-16DF		497 240 238	6 8 12 14	0,8	SH 12x80 – M8 SH 16x85 – M8/M10/IG-M6 SH 16x130 – M8/M10/IG-M6 SH 20x85 – M12/M16/IG-M8/IG-M10 SH 20x130 – M12/M16/IG-M8/IG-M10 SH 20x200 – M12/M16/IG-M8/IG-M10	C18 - C20
7	Clay hollow brick Porotherm Homebrick		500 200 299	4 6 10	0,7	SH 12x80 – M8 SH 16x85 – M8/M10/IG-M6 SH 16x130 – M8/M10/IG-M6 SH 20x85 – M12/M16/IG-M8/IG-M10 SH 20x130 – M12/M16/IG-M8/IG-M10	C21 - C23
<b>EJOT Chemical Anchor MULTIFIX USF or MULTIFIX USF winter for masonry</b>						<b>Annex B 2</b>	
<b>Intended Use</b> Brick types and properties with corresponding fastening elements							

Table B1: Overview brick types and properties with corresponding fastening elements (Anchor and Sleeves) (continue)							
Brick-No.	Brick type	Picture	Brick size	Compressive strength	Bulk density	Sleeve - Anchor type	Annex
			length width height [mm]				
<b>Clay masonry units according EN 771-1</b>							
8	Clay hollow brick BGV Thermo		500 200 314	4 6 10	0,6	SH 12x80 – M8 SH 16x85 – M8/M10/IG-M6 SH 16x130 – M8/M10/IG-M6 SH 20x85 – M12/M16/IG-M8/IG-M10 SH 20x130 – M12/M16/IG-M8/IG-M10	C24 - C26
9	Clay hollow brick Calibric R+		500 200 314	6 9 12	0,6	SH 12x80 – M8 SH 16x85 – M8/M10/IG-M6 SH 16x130 – M8/M10/IG-M6 SH 20x85 – M12/M16/IG-M8/IG-M10 SH 20x130 – M12/M16/IG-M8/IG-M10	C27- C29
10	Clay hollow brick Urbanbric		560 200 274	6 9 12	0,7	SH 12x80 – M8 SH 16x85 – M8/M10/IG-M6 SH 16x130 – M8/M10/IG-M6 SH 20x85 – M12/M16/IG-M8/IG-M10 SH 20x130 – M12/M16/IG-M8/IG-M10	C30 - C32
11	Clay hollow brick Brique creuse C40		500 200 200	4 8 12	0,7	SH 12x80 – M8 SH 16x85 – M8/M10/IG-M6 SH 16x130 – M8/M10/IG-M6 SH 20x85 – M12/M16/IG-M8/IG-M10 SH 20x130 – M12/M16/IG-M8/IG-M10	C33 - C35
12	Clay hollow brick Blocchi Leggeri		250 120 250	4 6 8 12	0,6	SH 12x80 – M8 SH 16x85 – M8/M10/IG-M6 SH 16x130 – M8/M10/IG-M6 SH 20x85 – M12/M16/IG-M8/IG-M10 SH 20x130 – M12/M16/IG-M8/IG-M10 SH 20x200 – M12/M16/IG-M8/IG-M10	C36 - C38
13	Clay hollow brick Doppio Uni		250 120 120	10 16 20 28	0,9	SH 12x80 – M8 SH 16x85 – M8/M10/IG-M6 SH 16x130 – M8/M10/IG-M6 SH 20x85 – M12/M16/IG-M8/IG-M10 SH 20x130 – M12/M16/IG-M8/IG-M10 SH 20x200 – M12/M16/IG-M8/IG-M10	C39 - C41
<b>Light weight concrete according EN 771-3</b>							
14	Hollow light weight concrete Bloc creux B40		494 200 190	4	0,8	SH 12x80 – M8 SH 16x85 – M8/M10/IG-M6 SH 16x130 – M8/M10/IG-M6 SH 20x85 – M12/M16/IG-M8/IG-M10 SH 20x130 – M12/M16/IG-M8/IG-M10	C42 - C43
15	Solid light weight concrete		300 123 248	2	0,6	M8/M10/M12/M16/IG-M6/IG-M8/IG-M10 SH 12x80 – M8 SH 16x85 – M8/M10/IG-M6 SH 16x130 – M8/M10/IG-M6 SH 20x85 – M12/M16/IG-M8/IG-M10 SH 20x130 – M12/M16/IG-M8/IG-M10 SH 20x200 – M12/M16/IG-M8/IG-M10	C44 - C45
<b>EJOT Chemical Anchor MULTIFIX USF or MULTIFIX USF winter for masonry</b>						<b>Annex B 3</b>	
<b>Intended Use</b> Brick types and properties with corresponding fastening elements							

**Installation: Steel Brush**



**Table B2: Installation parameters in autoclaved aerated concrete AAC and solid masonry (without sleeve)**

Anchor size			M8	M10	IG-M6	M12	IG-M8	M16	IG-M10
Nominal drill hole diameter	$d_0$	[mm]	10	12		14		18	
Drill hole depth	$h_0$	[mm]	80	90		100		100	
Effective anchorage depth	$h_{ef}$	[mm]	80	90		100		100	
Minimum wall thickness	$h_{min}$	[mm]	$h_{ef} + 30$						
Diameter of clearance hole in the fixture	$d_f \leq$	[mm]	9	12	7	14	9	18	12
Diameter of steel brush	$d_b$	[mm]	12	14		16		20	
Minimum diameter of steel brush	$d_{b,min}$	[mm]	10,5	12,5		14,5		18,5	
Max installation torque moment	$T_{inst,max}$	[Nm]	2 (14 for Mz DF)						

**Table B3: Installation parameters in solid and hollow masonry (with sleeve)**

Anchor size			M8	M8 / M10 / IG-M6	M12 / M16 / IG-M8 / IG-M10			
Sleeve			12x80	16x85	16x130	20x85	20x130	20x200
Nominal drill hole diameter	$d_0$	[mm]	12	16	16	20	20	20
Drill hole depth	$h_0$	[mm]	85	90	135	90	135	205
Effective anchorage depth	$h_{ef}$	[mm]	80	85	130	85	130	200
Minimum wall thickness	$h_{min}$	[mm]	115	115	175	115	175	240
Diameter of clearance hole in the fixture	$d_f \leq$	[mm]	9	7 (IG-M6) / 9 (M8) / 12 (M10)		9 (IG-M8) / 12 (IG-M10) / 14 (M12) / 18 (M16)		
Diameter of steel brush	$d_b$	[mm]	14	18		22		
Minimum diameter of steel brush	$d_{b,min}$	[mm]	12,5	16,5		20,5		
Max installation torque moment	$T_{inst,max}$	[Nm]	2					

**EJOT Chemical Anchor MULTIFIX USF or MULTIFIX USF winter for masonry**

**Intended Use**  
Installation parameters and cleaning brush

**Annex B 4**

**Table B4: Maximum working time and minimum curing time  
MULTIFIX USF**

Temperature in the base material T	Temperature of cartridge	Gelling- / working time	Minimum curing time in dry base material <sup>1)</sup>
- 10°C to - 6°C	+15°C to +40°C	90 min	24 h
- 5°C to - 1°C	+5°C to +40°C	90 min	14 h
0°C to + 4 °C		45 min	7 h
+ 5 °C to + 9 °C		25 min	2 h
+ 10 °C to + 19 °C		15 min	80 min
+ 20 °C to + 29 °C		6 min	45 min
+ 30 °C to + 34 °C		4 min	25 min
+ 35 °C to + 39 °C		2 min	20 min
+ 40°C		1,5 min	15 min

<sup>1)</sup> In wet base material the curing time **must** be doubled

**Table B5: Maximum working time and minimum curing time  
MULTIFIX USF winter**

Temperature in the base material T	Temperature of cartridge	Gelling- / working time	Minimum curing time in dry base material <sup>1)</sup>
- 20 °C to - 16 °C	-20°C to +10°C	75 min	24 h
- 15 °C to - 11 °C		55 min	16 h
- 10 °C to - 6 °C		35 min	10 h
- 5 °C to - 1 °C		20 min	5 h
0 °C to + 4 °C		10 min	2,5 h
+ 5 °C to + 9 °C		6 min	80 min
+ 10°C		6 min	60 min

<sup>1)</sup> In wet base material the curing time **must** be doubled

**EJOT Chemical Anchor MULTIFIX USF or MULTIFIX USF winter for masonry**

**Intended Use**  
Gelling and Curing times

**Annex B 5**

## Installation Instructions

### Preparation of cartridge

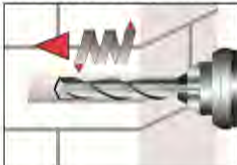


1. Remove the cap and attach the supplied static-mixing nozzle to the cartridge and load the cartridge into the correct dispensing tool. In case of a foil tube cartridge, cut off the clip before use. For every working interruption longer than the recommended working time (Table B4 and B5) as well as for new cartridges, a new static-mixer shall be used.

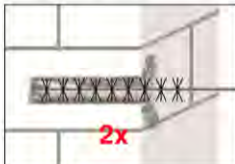


2. Initial adhesive is not suitable for fixing the anchor. Prior to dispensing into the anchor hole, squeeze out separately a minimum of three full strokes, for foil tube cartridges six full strokes and discard non-uniformly mixed adhesive components until the mortar shows a consistent grey colour.

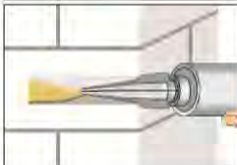
### Installation in solid masonry (without sleeve)



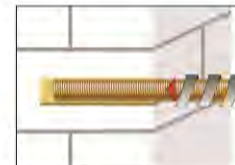
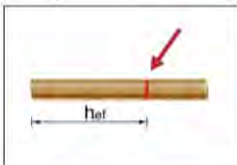
3. Holes to be drilled perpendicular to the surface of the base material by using a hard-metal tipped hammer drill bit. Drill a hole, with drilling method according to Annex C4-C45, into the base material, with nominal drill hole diameter and bore hole depth according to the size and embedment depth required by the selected anchor. In case of aborted drill hole the drill hole shall be filled with mortar.



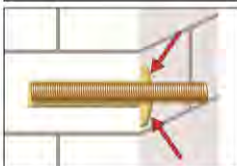
4. Blow out from the bottom of the bore hole two times. Attach the appropriate sized brush ( $> d_{b,min}$  Table B2 or B3) to a drilling machine or a battery screwdriver, brush the hole clean two times, and finally blow out the hole again two times.



5. Starting from the bottom or back of the cleaned anchor hole, fill the hole up to min two-thirds with adhesive. Slowly withdraw the static mixing nozzle will avoid creating air pockets. Observe the gel-/ working times given in Table B4 and B5.

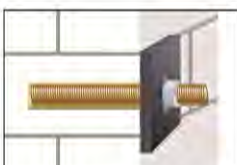


6. The position of the embedment depth shall be marked on the threaded rod. Push the threaded rod into the anchor hole while turning slightly to ensure positive distribution of the adhesive until the embedment depth is reached. The anchor shall be free of dirt, grease, oil or other foreign material.



7. Be sure that the annular gap is fully filled with mortar. If no excess mortar is visible at the top of the hole, the application has to be renewed.

8. Allow the adhesive to cure to the specified curing time prior to applying any load or torque. Do not move or load the anchor until it is fully cured (attend Table B4 and B5).



9. After full curing, the fixture can be installed with up to the max. installation torque (see Annex B4) by using a calibrated torque wrench.

**EJOT Chemical Anchor MULTIFIX USF or MULTIFIX USF winter for masonry**

#### Intended Use

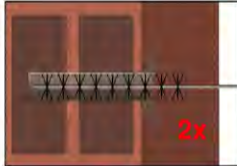
Installation instructions Solid masonry and Autoclaved Aerated Concrete

**Annex B 6**

### Installation in solid and hollow masonry (with sleeve)



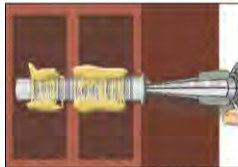
3. Holes to be drilled perpendicular to the surface of the base material by using a hard-metal tipped hammer drill bit. Drill a hole, with drill method according to Annex C4 – C45, into the base material, with nominal drill hole diameter and bore hole depth according to the size and embedment depth required by the selected anchor.



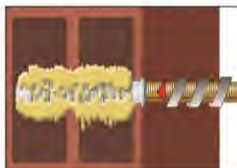
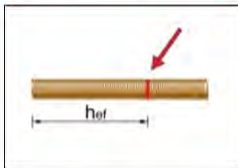
4. Blow out from the bottom of the bore hole two times. Attach the appropriate sized brush (>  $d_{b,min}$  Table B3) to a drilling machine or a battery screwdriver, brush the hole clean two times, and finally blow out the hole again two times.



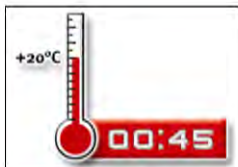
5. Insert the perforated sleeve flush with the surface of the masonry or plaster. Only use sleeves that have the right length. Never cut the sleeve.



6. Starting from the bottom or back fill the sleeve with adhesive. For embedment depth equal to or larger than 130 mm an extension nozzle shall be used. For quantity of mortar attend cartridges label installation instructions. Observe the gel-/ working times given in Table B4 and B5.



7. The position of the embedment depth shall be marked on the threaded rod. Push the threaded rod into the anchor hole while turning slightly to ensure positive distribution of the adhesive until the embedment depth is reached. The anchor shall be free of dirt, grease, oil or other foreign material.



8. Allow the adhesive to cure to the specified curing time prior to applying any load or torque. Do not move or load the anchor until it is fully cured (attend Table B4 and B5).



9. After full curing, the fixture can be installed with up to the max. installation torque (see Annex B4) by using a calibrated torque wrench.

EJOT Chemical Anchor MULTIFIX USF or MULTIFIX USF winter for masonry

**Intended Use**

Installation instructions hollow brick

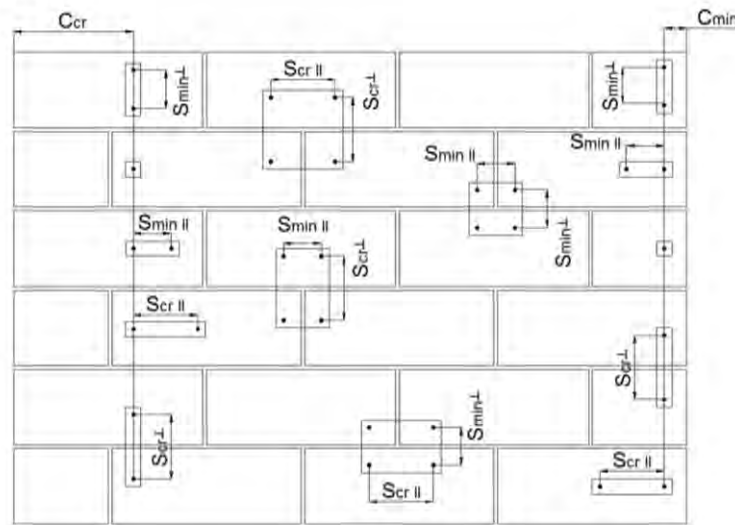
Annex B 7



Table C1: $\beta$ -factor for job-site testing under tension loading							
Brick-No. and abbreviation	Installation & Use category	$\beta$ -factor					
		$T_a: 40^\circ\text{C} / 24^\circ\text{C}$		$T_b: 80^\circ\text{C} / 50^\circ\text{C}$		$T_c: 120^\circ\text{C} / 72^\circ\text{C}$	
		d/d	w/d w/w	d/d	w/d w/w	d/d	w/d w/w
1 AAC6	For all sizes	0,95	0,86	0,81	0,73	0,81	0,73
2 KS-NF	$d_0 \leq 14$ mm	0,93	0,80	0,87	0,74	0,65	0,56
	$d_0 \geq 16$ mm	0,93	0,93	0,87	0,87	0,65	0,65
3 KSL-3DF	$d_0 \leq 12$ mm	0,93	0,80	0,87	0,74	0,65	0,56
	$d_0 \geq 16$ mm	0,93	0,93	0,87	0,87	0,65	0,65
4 KSL-12DF	$d_0 \leq 12$ mm	0,93	0,80	0,87	0,74	0,65	0,56
	$d_0 \geq 16$ mm	0,93	0,93	0,87	0,87	0,65	0,65
5 MZ-DF	For all sizes	0,86	0,86	0,86	0,86	0,73	0,73
6 Hz-16DF							
7 Porotherm Homebric							
8 BGV-Thermo							
9 Calibric R+							
10 Urbanbric							
11 Brique creuse C40							
12 Blocchi Leggeri							
13 Doppio Uni							
14 Bloc creux B40							
15 Solid light weight concrete	$d_0 \leq 12$ mm	0,93	0,80	0,87	0,74	0,65	0,56
	$d_0 \geq 16$ mm	0,93	0,93	0,87	0,87	0,65	0,65
<b>EJOT Chemical Anchor MULTIFIX USF or MULTIFIX USF winter for masonry</b>						<b>Annex C 1</b>	
<b>Performances</b> $\beta$ -factors for job site testing under tension load							

<b>Table C2: Characteristic steel resistance</b>									
<b>Size</b>			<b>IG-M6</b>	<b>IG-M8</b>	<b>IG-M10</b>	<b>M8</b>	<b>M10</b>	<b>M12</b>	<b>M16</b>
<b>Characteristic tension resistance</b>									
steel, property class 4.6	$N_{Rk,s}$	[kN]	-	-	-	15	23	34	63
	$\gamma_{Ms}$	[-]	-			2,0			
steel, property class 4.8	$N_{Rk,s}$	[kN]	-	-	-	15	23	34	63
	$\gamma_{Ms}$	[-]	-			1,5			
steel, property class 5.6	$N_{Rk,s}$	[kN]	10	18	29	18	29	42	79
	$\gamma_{Ms}$	[-]	2,0			2,0			
steel, property class 5.8	$N_{Rk,s}$	[kN]	10	17	29	18	29	42	79
	$\gamma_{Ms}$	[-]	1,5			1,5			
steel, property class 8.8	$N_{Rk,s}$	[kN]	16	27	46	29	46	67	126
	$\gamma_{Ms}$	[-]	1,5			1,5			
Stainless steel A4 / HCR, property class 70	$N_{Rk,s}$	[kN]	14	26	41	26	41	59	110
	$\gamma_{Ms}$	[-]	1,87			1,87			
Stainless steel A4 / HCR, property class 80	$N_{Rk,s}$	[kN]	16	29	46	29	46	67	126
	$\gamma_{Ms}$	[-]	1,6			1,6			
<b>Characteristic shear resistance</b>									
steel, property class 4.6	$V_{Rk,s}$	[kN]	-	-	-	7	12	17	31
	$\gamma_{Ms}$	[-]	-			1,67			
steel, property class 4.8	$V_{Rk,s}$	[kN]	-	-	-	7	12	17	31
	$\gamma_{Ms}$	[-]	-			1,25			
steel, property class 5.6	$V_{Rk,s}$	[kN]	5	9	15	9	15	21	39
	$\gamma_{Ms}$	[-]	1,67			1,67			
steel, property class 5.8	$V_{Rk,s}$	[kN]	5	9	15	9	15	21	39
	$\gamma_{Ms}$	[-]	1,25			1,25			
steel, property class 8.8	$V_{Rk,s}$	[kN]	8	14	23	15	23	34	63
	$\gamma_{Ms}$	[-]	1,25			1,25			
Stainless steel A4 / HCR, property class 70	$V_{Rk,s}$	[kN]	7	13	20	13	20	30	55
	$\gamma_{Ms}$	[-]	1,56			1,56			
Stainless steel A4 / HCR, property class 80	$V_{Rk,s}$	[kN]	8	15	23	15	23	34	63
	$\gamma_{Ms}$	[-]	1,33			1,33			
<b>Characteristic bending moment</b>									
steel, property class 4.6	$M_{Rk,s}$	[Nm]	-	-	-	15	30	52	133
	$\gamma_{Ms}$	[-]	-			1,67			
steel, property class 4.8	$M_{Rk,s}$	[Nm]	-	-	-	15	30	52	133
	$\gamma_{Ms}$	[-]	-			1,25			
steel, property class 5.6	$M_{Rk,s}$	[Nm]	8	19	37	19	37	66	167
	$\gamma_{Ms}$	[-]	1,67			1,67			
steel, property class 5.8	$M_{Rk,s}$	[Nm]	8	19	37	19	37	66	167
	$\gamma_{Ms}$	[-]	1,25			1,25			
steel, property class 8.8	$M_{Rk,s}$	[Nm]	12	30	60	30	60	105	266
	$\gamma_{Ms}$	[-]	1,25			1,25			
Stainless steel A4 / HCR, property class 70	$M_{Rk,s}$	[Nm]	11	26	52	26	52	92	233
	$\gamma_{Ms}$	[-]	1,56			1,56			
Stainless steel A4 / HCR, property class 80	$M_{Rk,s}$	[Nm]	12	30	60	30	60	105	266
	$\gamma_{Ms}$	[-]	1,33			1,33			
<b>EJOT Chemical Anchor MULTIFIX USF or MULTIFIX USF winter for masonry</b>						<b>Annex C 2</b>			
<b>Performances</b> Characteristic resistance under tension and shear load – steel failure									

### Spacing and edge distances



- $C_{cr}$  = Characteristic edge distance
- $C_{min}$  = Minimum Edge distance
- $S_{cr}$  = Characteristic spacing
- $S_{min}$  = Minimum spacing
- $S_{cr,II}; (S_{min,II})$  = Characteristic (minimum) spacing for anchors placed parallel to bed joint
- $S_{cr,\perp}; (S_{min,\perp})$  = Characteristic (minimum) spacing for anchors placed perpendicular to bed joint

Load direction \ Anchor position	Tension load	Shear load parallel to free edge	Shear load perpendicular to free edge
Anchors places parallel to bed joint $s_{cr,II}; (s_{min,II})$			
Anchors places perpendicular to bed joint $s_{cr,\perp}; (s_{min,\perp})$			

- $\alpha_{g,N,II} =$  Group factor in case of tension load for anchors placed parallel to the bed joint
- $\alpha_{g,V,II} =$  Group factor in case of shear load for anchors placed parallel to the bed joint
- $\alpha_{g,N,\perp} =$  Group factor in case of tension load for anchors placed perpendicular to the bed joint
- $\alpha_{g,V,\perp} =$  Group factor in case of shear load for anchors placed perpendicular to the bed joint

Group of two anchors:  $N_{RK}^g = \alpha_{g,N} * N_{RK}$  and  $V_{RK}^g = \alpha_{g,V} * V_{RK}$

Group of four anchors:  $N_{RK}^g = \alpha_{g,N,II} * \alpha_{g,N,\perp} * N_{RK}$  and  $V_{RK}^g = \alpha_{g,V,II} * \alpha_{g,V,\perp} * V_{RK}$

( $N_{RK}$ :  $N_{RK,b}$  or  $N_{RK,b,j}$  for  $c_{cr}$ )  
 ( $V_{RK}$ :  $V_{RK,c}$ ;  $V_{RK,c,j}$ ;  $V_{RK,b}$  or  $V_{RK,b,j}$  for  $c_{cr}$ )  
 (with the relevant  $\alpha_g$ )


**EJOT Chemical Anchor MULTIFIX USF or MULTIFIX USF winter for masonry**

**Performances**  
Edge distance and anchor spacing

**Annex C 3**

**Brick type: Autoclaved Aerated Concrete – AAC6**

**Table C3: Description of the brick**


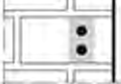
Brick type	Autoclaved Aerated Concrete AAC6	
Bulk density $\rho$ [kg/dm <sup>3</sup> ]	0,6	
Compressive strength $f_b \geq$ [N/mm <sup>2</sup> ]	6	
Code	EN 771-4	
Producer (country code)	e.g. Porit (DE)	
Brick dimensions [mm]	499 x 240 x 249	
Drilling method	Rotary	

**Table C4: Installation parameter**



Anchor size		[-]	M8	M10/IG-M6	M12/IG-M8	M16/IG-M10
Effective anchorage depth		[mm]	80	90	100	100
Edge distance	$C_{cr}$	[mm]	1,5* $h_{ef}$			
Minimum edge distance	$C_{min,N}$	[mm]	75			
	$C_{min,V,  }$ ( $C_{min,v,\perp}$ ) <sup>1)</sup>	[mm]	75 (1,5* $h_{ef}$ )			
Spacing	$S_{cr}$	[mm]	3* $h_{ef}$			
Minimum spacing	$S_{min}$	[mm]	100			

<sup>1)</sup>  $C_{min,v,||}$  for shear loading parallel to the free edge;  $C_{min,v,\perp}$  for shear loading perpendicular the free edge

**Table C5: Group factor for anchor group in case of tension loading**

Configuration		with $c \geq$	with $s \geq$			
: anchors placed parallel to horizontal joint 		125 (M8:120)	100	$\alpha_{g,N,  }$	[-]	1,8
		1,5* $h_{ef}$	3* $h_{ef}$			2,0
⊥: anchors placed perpendicular to horizontal joint 		75	100	$\alpha_{g,N,\perp}$	[-]	1,4
		1,5* $h_{ef}$	3* $h_{ef}$			2,0

**Table C6: Group factor for anchor group in case of shear loading parallel to free edge**

Configuration		with $c \geq$	with $s \geq$			
: anchors placed parallel to horizontal joint 		75	100	$\alpha_{g,V,  }$	[-]	1,2
		1,5* $h_{ef}$	3* $h_{ef}$			2,0
⊥: anchors placed perpendicular to horizontal joint 		1,5* $h_{ef}$	3* $h_{ef}$	$\alpha_{g,V,\perp}$	[-]	2,0

**EJOT Chemical Anchor MULTIFIX USF or MULTIFIX USF winter for masonry**

**Performances Autoclaved Aerated Concrete - AAC6**

Description of the brick  
Installation parameters

**Annex C 4**

**Brick type: Autoclaved Aerated Concrete – AAC6**

**Table C7: Group factor for anchor group in case of shear loading perpendicular to free edge**

Configuration		with $c \geq$	with $s \geq$			
II: anchors placed parallel to horizontal joint		1,5*hef	3,0*hef	$\alpha_{g,V,II}$	[-]	2,0
I: anchors placed perpendicular to horizontal joint		1,5*hef	3,0*hef	$\alpha_{g,V,I}$		2,0

**Table C8: Characteristic values of resistance under tension and shear loads**

Anchor size	Effective anchorage depth	Characteristic resistance						
		Use category						
		d/d			w/w w/d			d/d w/d w/w
		40°C/24°C	80°C/50°C	120°C/72°C	40°C/24°C	80°C/50°C	120°C/72°C	For all temperature range
	$h_{ef}$ [mm]	$N_{Rk,b} = N_{Rk,p}^{1)}$			$N_{Rk,b} = N_{Rk,p}^{1)}$			$V_{Rk,b}^{2)3)}$
<b>Compressive strength <math>f_b \geq 6 \text{ N/mm}^2</math></b>								
M8	80	2,5 (2,0)	2,5 (1,5)	2,0 (1,2)	2,5 (1,5)	2,0 (1,5)	1,5 (1,2)	6,0
M10/IG-M6	90	4,0 (2,5)	3,0 (2,0)	2,5 (1,5)	3,5 (2,5)	3,0 (2,0)	2,5 (1,5)	10,0
M12/IG-M8	100	5,0 (3,5)	4,0 (3,0)	3,0 (2,5)	4,5 (3,0)	3,5 (2,5)	3,0 (2,5)	10,0
M16/IG-M10	100	6,5 (4,5)	5,5 (3,5)	4,0 (3,0)	5,5 (4,0)	5,0 (3,5)	4,0 (3,0)	10,0

- 1) Values are valid for  $c_{cr}$ , values in brackets are valid for single anchors with  $c_{min}$   
 2) For calculation of  $V_{Rk,c}$  see ETAG029, Annex C;  
 3) The values are valid for steel 5.6 or greater. For steel 4.6 and 4.8 multiply  $V_{Rk,b}$  by 0,8

**Table C9: Displacements**

Anchor size	$h_{ef}$ [mm]	N [kN]	$\delta_N / N$ [mm/kN]	$\delta_{N0}$ [mm]	$\delta_{N\infty}$ [mm]	V [kN]	$\delta_{V0}$ [mm]	$\delta_{V\infty}$ [mm]
M8	80	0,9	0,18	0,16	0,32	1,3	0,8	1,20
M10/IG-M6	90	1,4		0,26	0,51	1,8	1,2	1,80
M12/IG-M8	100	1,8	0,08	0,14	0,29	2,1	1,4	2,10
M16/IG-M10	100	2,3		0,19	0,37	2,3	1,5	2,25

**EJOT Chemical Anchor MULTIFIX USF or MULTIFIX USF winter for masonry**

**Performances Autoclaved Aerated Concrete – AAC6**


Installation parameters (continue)

Characteristic values of resistance under tension and shear load / Displacements

**Annex C 5**

**Brick type: Calcium silicate solid brick KS-NF**

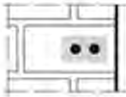
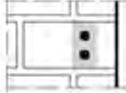
**Table C10: Description of the brick**

Brick type	Calcium silicate solid brick KS-NF	
Bulk density $\rho$ [kg/dm <sup>3</sup> ]	2,0	
Compressive strength $f_b \geq$ [N/mm <sup>2</sup> ]	10, 20 or 27	
Code	EN 771-2	
Producer (country code)	e.g. Wemding (DE)	
Brick dimensions [mm]	240 x 115 x 71	
Drilling method	Hammer	



**Table C11: Installation parameter**

Anchor size		[-]	All sizes
Edge distance	$c_{cr}$	[mm]	$1,5 \cdot h_{ef}$
Minimum edge distance	$c_{min}$	[mm]	60
Spacing	$s_{cr}$	[mm]	$3 \cdot h_{ef}$
Minimum spacing	$s_{min}$	[mm]	120

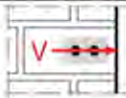

**Table C12: Group factor for anchor group in case of tension loading**

Configuration		with $c \geq$	with $s \geq$			
II: anchors placed parallel to horizontal joint 		60	120	$\alpha_{g,N,II}$	[-]	1,0
		140	120			1,5
		$1,5 \cdot h_{ef}$	$3 \cdot h_{ef}$			2,0
⊥: anchors placed perpendicular to horizontal joint 		60	120	$\alpha_{g,N,\perp}$	[-]	0,5
		$1,5 \cdot h_{ef}$	120			1,0
		$1,5 \cdot h_{ef}$	$3 \cdot h_{ef}$			2,0

**Table C13: Group factor for anchor group in case of shear loading parallel to free edge**

Configuration		with $c \geq$	with $s \geq$			
II: anchors placed parallel to horizontal joint 		60	120	$\alpha_{g,V,II}$	[-]	1,0
		115	120			1,7
		$1,5 \cdot h_{ef}$	$3 \cdot h_{ef}$			2,0
⊥: anchors placed perpendicular to horizontal joint 		60	120	$\alpha_{g,V,\perp}$	[-]	1,0
		$1,5 \cdot h_{ef}$	120			1,0
		$1,5 \cdot h_{ef}$	$3 \cdot h_{ef}$			2,0

**Table C14: Group factor for anchor group in case of shear loading perpendicular to free edge**

Configuration		with $c \geq$	with $s \geq$			
II: anchors placed parallel to horizontal joint 		60	120	$\alpha_{g,V,II}$	[-]	1,0
		$1,5 \cdot h_{ef}$	$3 \cdot h_{ef}$			2,0
⊥: anchors placed perpendicular to horizontal joint 		60	120	$\alpha_{g,V,\perp}$	[-]	1,0
		$1,5 \cdot h_{ef}$	$3 \cdot h_{ef}$			2,0

**EJOT Chemical Anchor MULTIFIX USF or MULTIFIX USF winter for masonry**

**Performances calcium solid brick KS-NF**  
Installation parameters

**Annex C 6**

<b>Brick type: Calcium silicate solid brick KS-NF</b>									
<b>Table C15: Characteristic values of resistance under tension and shear loads</b>									
Anchor size	Sleeve	Effective anchorage depth $h_{ef}$ [mm]	Characteristic resistance						
			Use category						
			d/d			w/d w/w			d/d w/d w/w
			40°C/24°C	80°C/50°C	120°C/72°C	40°C/24°C	80°C/50°C	120°C/72°C	For All temperature range
$h_{ef}$	$N_{Rk,b} = N_{Rk,p}^{1)}$			$N_{Rk,b} = N_{Rk,p}^{1)}$			$V_{Rk,b}^{2)3)}$		
[mm]	[kN]								
<b>Compressive strength <math>f_b \geq 10 \text{ N/mm}^2</math></b>									
M8	-	80	4,5 (2,0)	4,5 (2,0)	3,0 (1,5)	3,5 (1,5)	3,5 (1,5)	2,5 (1,2)	2,5 (1,5)
M10 / IG-M6	-	90	4,5 (2,0)	4,5 (2,0)	3,0 (1,5)	3,5 (1,5)	3,5 (1,5)	2,5 (1,2)	3,0 (2,0)
M12 / IG-M8	-	100	4,5 (2,0)	4,5 (2,0)	3,0 (1,5)	3,5 (1,5)	3,5 (1,5)	2,5 (1,2)	2,5 (1,5)
M16 / IG-M10	-	100	3,5 (1,5)	3,5 (1,5)	2,5 (1,2)	3,0 (1,5)	3,5 (1,5)	2,0 (0,9)	2,5 (1,5)
M8	12x80	80	3,5 (1,5)	3,5 (1,5)	2,5 (1,2)	3,5 (1,5)	3,0 (1,5)	2,5 (1,2)	2,5 (1,5)
M8 / M10 / IG-M6	16x85	85	3,5 (1,5)	3,0 (1,5)	2,0 (0,9)	3,5 (1,5)	3,0 (1,5)	2,5 (1,2)	2,5 (1,5)
	16x130	130	3,5 (1,5)	3,0 (1,5)	2,0 (0,9)	3,5 (1,5)	3,0 (1,5)	2,5 (1,2)	2,5 (1,5)
M12 / M16 / IG-M8 / IG-M10	20x85	85	3,0 (1,5)	2,5 (1,2)	2,0 (0,9)	3,0 (1,5)	2,5 (1,2)	2,0 (0,9)	2,5 (1,5)
	20x130	130	3,0 (1,5)	2,5 (1,2)	2,0 (0,9)	3,0 (1,5)	2,5 (1,2)	2,0 (0,9)	2,5 (1,5)
	20x200	200	3,0 (1,5)	2,5 (1,2)	2,0 (0,9)	3,0 (1,5)	2,5 (1,2)	2,0 (0,9)	2,5 (1,5)
<b>Compressive strength <math>f_b \geq 20 \text{ N/mm}^2</math></b>									
M8	-	80	6,0 (3,0)	5,5 (2,5)	4,0 (2,0)	5,0 (2,5)	5,0 (2,5)	3,5 (1,5)	4,0 (2,5)
M10 / IG-M6	-	90	6,0 (3,0)	5,5 (2,5)	4,0 (2,0)	5,0 (2,5)	5,0 (2,5)	3,5 (1,5)	4,5 (2,5)
M12 / IG-M8	-	100	6,0 (3,0)	5,5 (2,5)	4,0 (2,0)	5,0 (2,5)	5,0 (2,5)	3,5 (1,5)	4,0 (2,5)
M16 / IG-M10	-	100	5,0 (2,5)	5,0 (2,5)	3,5 (1,5)	5,0 (2,5)	5,0 (2,5)	3,5 (1,5)	4,0 (2,5)
M8	12x80	80	5,5 (2,5)	5,0 (2,5)	3,5 (1,5)	4,5 (2,0)	4,5 (2,0)	3,0 (1,5)	4,0 (2,5)
M8 / M10 / IG-M6	16x85	85	5,0 (2,5)	4,5 (2,0)	3,5 (1,5)	5,0 (2,5)	4,5 (2,0)	3,5 (1,5)	4,0 (2,5)
	16x130	130	5,0 (2,5)	4,5 (2,0)	3,5 (1,5)	5,0 (2,5)	4,5 (2,0)	3,5 (1,5)	4,0 (2,5)
M12 / M16 / IG-M8 / IG-M10	20x85	85	4,0 (2,0)	4,0 (2,0)	3,0 (1,5)	4,0 (2,0)	4,0 (2,0)	3,0 (1,5)	4,0 (2,5)
	20x130	130	4,0 (2,0)	4,0 (2,0)	3,0 (1,5)	4,0 (2,0)	4,0 (2,0)	3,0 (1,5)	4,0 (2,5)
	20x200	200	4,0 (2,0)	4,0 (2,0)	3,0 (1,5)	4,0 (2,0)	4,0 (2,0)	3,0 (1,5)	4,0 (2,5)
<sup>1)</sup> Values are valid for $C_{cr}$ , values in brackets are valid for single anchors with $C_{min}$ <sup>2)</sup> For $C_{cr}$ calculation of $V_{Rk,c}$ see ETAG 029, Annex C; values in brackets $V_{Rk,b} = V_{Rk,c}$ for single anchors with $C_{min}$ <sup>3)</sup> The values are valid for steel 5.6 or greater. For steel 4.6 and 4.8 multiply $V_{Rk,b}$ by 0,8									
<b>EJOT Chemical Anchor MULTIFIX USF or MULTIFIX USF winter for masonry</b>							<b>Annex C 7</b>		
<b>Performances calcium solid brick KS-NF</b> Characteristic values of resistance under tension and shear load									

**Brick type: Calcium silicate solid brick KS-NF**

**Table C16: Characteristic values of resistance under tension and shear loads (continue)**

Anchor size	Sleeve	Effective anchorage depth $h_{ef}$ [mm]	Characteristic resistance						
			Use category						
			d/d			w/d w/w			d/d w/d w/w
			40°C/24°C	80°C/50°C	120°C/72°C	40°C/24°C	80°C/50°C	120°C/72°C	For All temperature range
$h_{ef}$	$N_{Rk,b} = N_{Rk,p}^{1)}$			$N_{Rk,b} = N_{Rk,p}^{1)}$			$V_{Rk,b}^{2,3)}$		
[mm]	[kN]								
<b>Compressive strength <math>f_b \geq 27 \text{ N/mm}^2</math></b>									
M8	-	80	7,0 (3,5)	6,5 (3,0)	5,0 (2,5)	6,0 (3,0)	5,5 (2,5)	4,0 (2,0)	4,5 (2,5)
M10 / IG-M6	-	90	7,0 (3,5)	6,5 (3,0)	5,0 (2,5)	6,0 (3,0)	5,5 (2,5)	4,0 (2,0)	5,5 (3,0)
M12 / IG-M8	-	100	7,0 (3,5)	6,5 (3,0)	5,0 (2,5)	6,0 (3,0)	5,5 (2,5)	4,0 (2,0)	4,5 (2,5)
M16 / IG-M10	-	100	6,0 (3,0)	5,5 (2,5)	4,5 (2,0)	6,0 (3,0)	5,5 (2,5)	4,0 (2,0)	4,5 (2,5)
M8	12x80	80	6,5 (3,0)	6,0 (3,0)	4,5 (2,0)	5,5 (2,5)	5,0 (2,5)	3,5 (1,5)	4,5 (2,5)
M8 / M10/ IG-M6	16x85	85	5,5 (2,5)	5,0 (2,5)	4,0 (2,0)	5,5 (2,5)	5,0 (2,5)	4,0 (2,0)	4,5 (2,5)
	16x130	130	5,5 (2,5)	5,0 (2,5)	4,0 (2,0)	5,5 (2,5)	5,0 (2,5)	4,0 (2,0)	4,5 (2,5)
M12 / M16 / IG-M8 / IG-M10	20x85	85	5,0 (2,5)	4,5 (2,0)	3,5 (1,5)	5,0 (2,5)	4,5 (2,0)	3,5 (1,5)	4,5 (2,5)
	20x130	130	5,0 (2,5)	4,5 (2,0)	3,5 (1,5)	5,0 (2,5)	4,5 (2,0)	3,5 (1,5)	4,5 (2,5)
	20x200	200	5,0 (2,5)	4,5 (2,0)	3,5 (1,5)	5,0 (2,5)	4,5 (2,0)	3,5 (1,5)	4,5 (2,5)

- 1) Values are valid for  $c_{cr}$ , values in brackets are valid for single anchors with  $c_{min}$   
 2) For  $c_{cr}$  calculation of  $V_{Rk,c}$  see ETAG 029, Annex C; values in brackets  $V_{Rk,b} = V_{Rk,c}$  for single anchors with  $c_{min}$   
 3) The values are valid for steel 5.6 or greater. For steel 4.6 and 4.8 multiply  $V_{Rk,b}$  by 0,8

**Table C17: Displacements**

Anchor size	Sleeve	Effective anchorage depth $h_{ef}$ [mm]	N [kN]	$\delta_N / N$ [mm/kN]	$\delta_{N0}$ [mm]	$\delta_{N\infty}$ [mm]	V [kN]	$\delta_{V0}$ [mm]	$\delta_{V\infty}$ [mm]
M8	-	80	2,0	0,15	0,30	0,60	1,7	0,90	1,35
M10 / IG-M6	-	90							
M12 / IG-M8	-	100							
M16 / IG-M10	-	100	1,7		0,26	0,51	1,7	0,90	1,35
M8	12x80	80	1,4		0,21	0,43			
M8 / M10/ IG-M6	16x85	85							
	16x130	130							
M12 / M16 / IG-M8 / IG-M10	20x85	85	1,3		0,19	0,39			
	20x130	130							
	20x200	200							

**EJOT Chemical Anchor MULTIFIX USF or MULTIFIX USF winter for masonry**

**Performances calcium solid brick KS-NF**


Characteristic values of resistance under tension and shear load (continue)  
Displacements

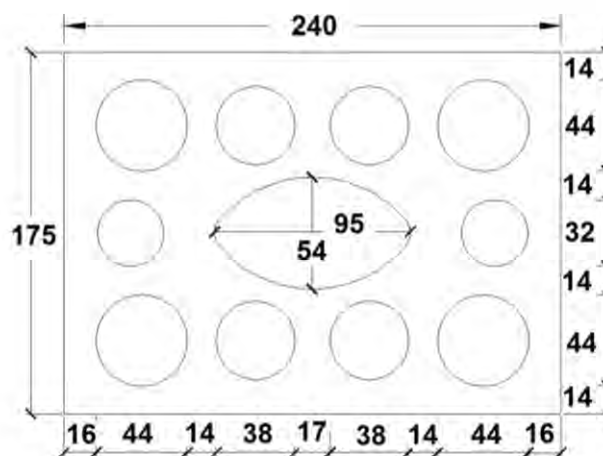
**Annex C 8**



**Brick type: Calcium silicate hollow brick KS L-3DF**

**Table C18: Description of the brick**

Brick type	Calcium silicate hollow brick KSL-3DF	
Bulk density $\rho$ [kg/dm <sup>3</sup> ]	1,4	
Compressive strength $f_b \geq$ [N/mm <sup>2</sup> ]	8, 12 or 14	
Code	EN 771-2	
Producer (country code)	e.g. Wemding (DE)	
Brick dimensions [mm]	240 x 175 x 113	
Drilling method	Rotary	

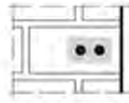
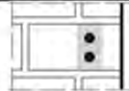


**Table C19: Installation parameters**

Anchor size		[-]	All sizes
Edge distance	$C_{cr}$	[mm]	100 (120) <sup>1)</sup>
Minimum edge distance	$C_{min}$	[mm]	60
Spacing	$S_{cr,II}$	[mm]	240
	$S_{cr,I}$	[mm]	120
Minimum spacing	$S_{min}$	[mm]	120

<sup>1)</sup> Value in brackets for SH20x85; SH20x130 and SH20x200

**Table C20: Group factor for anchor group in case of tension loading**

Configuration		with $c \geq$	with $s \geq$	$\alpha_{g,N,II}$	[-]	
II: anchors placed parallel to horizontal joint		60	120			
		$C_{cr}$	240	2,0		
		160	120	2,0		
I: anchors placed perpendicular to horizontal joint		60	120	$\alpha_{g,N,I}$		1,0
		$C_{cr}$	120			2,0

**EJOT Chemical Anchor MULTIFIX USF or MULTIFIX USF winter for masonry**

**Performances calcium hollow brick KS L-3DF**

Description of the brick  
Installation parameters

**Annex C 9**

English translation prepared by DIBt

Brick type: Calcium silicate hollow brick KS L-3DF										
Table C21: Group factor for anchor group in case of shear loading parallel to free edge										
Configuration		with $c \geq$			with $s \geq$					
II: anchors placed parallel to horizontal joint		60			120			$\alpha_{g,V,II}$	[-]	1,0
		160			120					1,6
		$c_{Cr}$			240					2,0
⊥: anchors placed perpendicular to horizontal joint		60			120			$\alpha_{g,V,\perp}$	[-]	1,0
		$c_{Cr}$			120					2,0
Table C22: Group factor for anchor group in case of shear loading perpendicular to free edge										
Configuration		with $c \geq$			with $s \geq$					
II: anchors placed parallel to horizontal joint		60			120			$\alpha_{g,V,II}$	[-]	1,0
		$c_{Cr}$			240					2,0
⊥: anchors placed perpendicular to horizontal joint		60			120			$\alpha_{g,V,\perp}$	[-]	1,0
		$c_{Cr}$			120					2,0
Table C23: Characteristic values of resistance under tension and shear loads										
Anchor size	Sleeve	Effective anchorage depth	Characteristic resistance							
			Use category							
			d/d			w/d; w/w			d/d; w/d; w/w	
			40°C/24°C	80°C/50°C	120°C/72°C	40°C/24°C	80°C/50°C	120°C/72°C	For all temperature range	
			$N_{Rk,b} = N_{Rk,p}^{1)}$			$N_{Rk,b} = N_{Rk,p}^{1)}$			$V_{Rk,b}^{4)}$	
		$h_{ef}$	[kN]							
		[mm]								
Compressive strength $f_b \geq 8 \text{ N/mm}^2$										
M8	12x80	80	1,5	1,5	1,2	1,5	1,2	0,9	$2,5^{2)}$ ( $0,9^{3)}$	
M8 / M10 / IG-M6	16x85	85	1,5	1,5	1,2	1,5	1,5	1,2	$4,0^{2)}$ ( $1,5^{3)}$	
	16x130	130	1,5	1,5	1,2	1,5	1,5	1,2	$4,0^{2)}$ ( $1,5^{3)}$	
M12 / M16 / IG-M8 / IG-M10	20x85	85	4,5	4,0	3,0	4,5	4,0	3,0	$4,0^{2)}$ ( $1,5^{3)}$	
	20x130	130	4,5	4,0	3,0	4,5	4,0	3,0	$4,0^{2)}$ ( $1,5^{3)}$	
	20x200	200	4,5	4,0	3,0	4,5	4,0	3,0	$4,0^{2)}$ ( $1,5^{3)}$	
Compressive strength $f_b \geq 12 \text{ N/mm}^2$										
M8	12x80	80	2,0	2,0	1,5	2,0	1,5	1,2	$3,0^{2)}$ ( $1,2^{3)}$	
M8 / M10 / IG-M6	16x85	85	2,0	2,0	1,5	2,0	2,0	1,5	$4,5^{2)}$ ( $1,5^{3)}$	
	16x130	130	2,5	2,5	1,5	2,5	2,5	1,5	$4,5^{2)}$ ( $1,5^{3)}$	
M12 / M16 / IG-M8 / IG-M10	20x85	85	6,0	5,5	4,0	6,0	5,5	4,0	$4,5^{2)}$ ( $1,5^{3)}$	
	20x130	130	6,0	5,5	4,0	6,0	5,5	4,0	$4,5^{2)}$ ( $1,5^{3)}$	
	20x200	200	6,0	5,5	4,0	6,0	5,5	4,0	$4,5^{2)}$ ( $1,5^{3)}$	
<sup>1)</sup> Values are valid for $c_{Cr}$ and $c_{min}$ <sup>2)</sup> $V_{Rk,c,II} = V_{Rk,b}$ valid for shear load parallel to free edge <sup>3)</sup> $V_{Rk,c,\perp} = V_{Rk,b}$ (values in brackets) valid for shear load in direction to free edge <sup>4)</sup> The values are valid for steel 5.6 or greater. For steel 4.6 and 4.8 multiply $V_{Rk,b}$ by 0,8										
<b>EJOT Chemical Anchor MULTIFIX USF or MULTIFIX USF winter for masonry</b>								<b>Annex C 10</b>		
<b>Performances calcium hollow brick KS L-3DF</b>										
Installation parameters (continue) Characteristic values of resistance under tension and shear load										

**Brick type: Calcium silicate hollow brick KS L-3DF**

**Table C24: Characteristic values of resistance under tension and shear loads (continue)**

Anchor size	Sleeve	Effective anchorage depth	Characteristic resistance						
			Use category						
			d/d			w/d w/w			d/d; w/d; w/w
			40°C/24°C	80°C/50°C	120°C/72°C	40°C/24°C	80°C/50°C	120°C/72°C	For all temperature range
		$h_{ef}$	$N_{RK,b} = N_{RK,p}^{1)}$			$N_{RK,b} = N_{RK,p}^{1)}$			$V_{RK,b}^{4)}$
		[mm]	[kN]						
<b>Compressive strength <math>f_b \geq 14 \text{ N/mm}^2</math></b>									
M8	12x80	80	2,5	2,5	1,5	2,0	2,0	1,5	3,5 <sup>2)</sup> (1,5) <sup>3)</sup>
M8 / M10 / IG-M6	16x85	85	2,5	2,5	1,5	2,5	2,5	1,5	6,0 <sup>2)</sup> (2,0) <sup>3)</sup>
	16x130	130	2,5	2,5	2,0	2,5	2,5	2,0	6,0 <sup>2)</sup> (2,0) <sup>3)</sup>
M12 / M16 / IG-M8 / IG-M10	20x85	85	6,5	6,0	4,5	6,5	6,0	4,5	6,0 <sup>2)</sup> (2,0) <sup>3)</sup>
	20x130	130	6,5	6,0	4,5	6,5	6,0	4,5	6,0 <sup>2)</sup> (2,0) <sup>3)</sup>
	20x200	200	6,5	6,0	4,5	6,5	6,0	4,5	6,0 <sup>2)</sup> (2,0) <sup>3)</sup>

- 1) Values are valid for  $C_{cr}$  and  $C_{min}$   
 2)  $V_{RK,c,II} = V_{RK,b}$  valid for shear load parallel to free edge  
 3)  $V_{RK,c,I} = V_{RK,b}$  (values in brackets) valid for shear load in direction to free edge  
 4) The values are valid for steel 5.6 or greater. For steel 4.6 and 4.8 multiply  $V_{RK,b}$  by 0,8

**Table C25: Displacements**

Anchor size	Sleeve	Effective anchorage depth $h_{ef}$	N	$\delta_N / N$	$\delta_{N0}$	$\delta_{N\infty}$	V	$\delta_{V0}$	$\delta_{V\infty}$
M8	12x80	80	0,71	0,90	0,64	1,29	1,0	1,0	1,50
M8 / M10 / IG-M6	16x85	85							
		16x130	130	1,86	0,90	1,67	3,34	1,7	1,9
M12 / M16 / IG-M8 / IG-M10	20x85	85							
		20x130	130						
	20x200	200							

**EJOT Chemical Anchor MULTIFIX USF or MULTIFIX USF winter for masonry**


**Performances calcium hollow brick KS L-3DF**

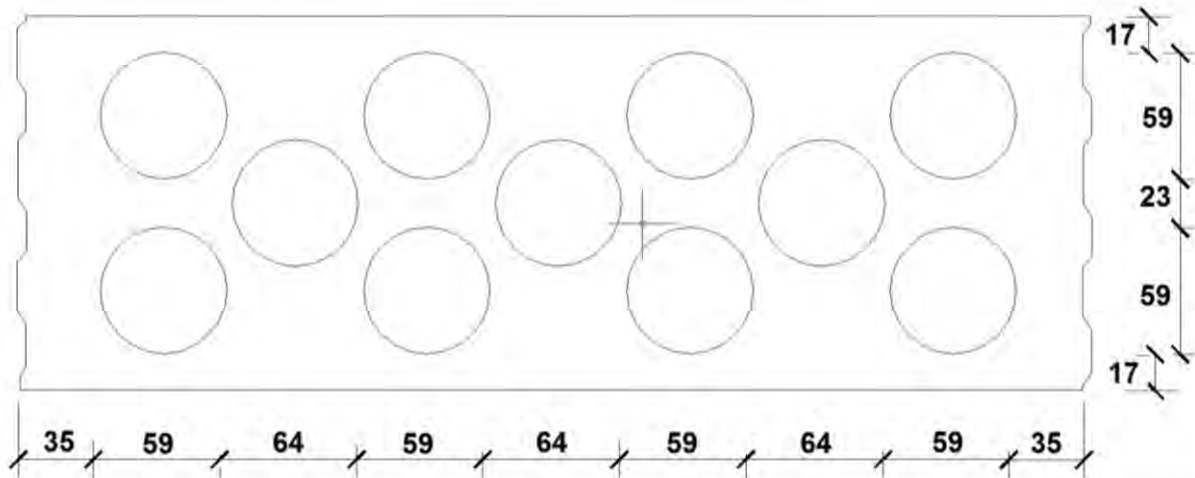
Characteristic values of resistance under tension and shear load (continue)  
Displacements

**Annex C 11**

**Brick type: Calcium silicate hollow brick KS L-12DF**

**Table C26: Description of the brick**

Brick type	Calcium silicate hollow brick KSL-12DF	
Bulk density $\rho$ [kg/dm <sup>3</sup> ]	1,4	
Compressive strength $f_b \geq$ [N/mm <sup>2</sup> ]	10, 12 or 16	
Code	EN 771-2	
Producer (country code)	e.g. Wemding (DE)	
Brick dimensions [mm]	498 x 175 x 238	
Drilling method	Rotary	



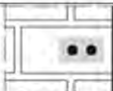
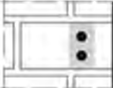
**Table C27: Installation parameters**

Anchor size		[-]	All sizes
Edge distance	$C_{cr}$	[mm]	100 (120) <sup>1)</sup>
Minimum edge distance	$C_{min}$ <sup>2)</sup>	[mm]	100 (120) <sup>1)</sup>
Spacing	$S_{cr,II}$	[mm]	498
	$S_{cr,L}$	[mm]	238
Minimum spacing	$S_{min}$	[mm]	120

<sup>1)</sup> Value in brackets for SH20x85 and SH20x130

<sup>2)</sup> For  $V_{Rk,c}$ :  $C_{min}$  according to ETAG 029, Annex C

**Table C28: Group factor for anchor group in case of tension loading**

Configuration		with $c \geq$	with $s \geq$			
II: anchors placed parallel to horizontal joint		100	120	$\alpha_{g,N,II}$	[-]	1,0
		$C_{cr}$	498			2,0
⊥: anchors placed perpendicular to horizontal joint		100	120	$\alpha_{g,N,L}$		1,0
		$C_{cr}$	238			2,0

**EJOT Chemical Anchor MULTIFIX USF or MULTIFIX USF winter for masonry**

**Performances Calcium hollow brick KS L-12DF**

Description of the brick  
Installation parameters

**Annex C 12**

**Brick type: Calcium silicate hollow brick KS L-12DF**

**Table C29: Group factor for anchor group in case of shear loading parallel to free edge**

Configuration		with $c \geq$	with $s \geq$		
II: anchors placed parallel to horizontal joint		$C_{Cr}$	498	$\alpha_{g,V,II}$	[-]
I: anchors placed perpendicular to horizontal joint		$C_{Cr}$	238	$\alpha_{g,V,I}$	

**Table C30: Group factor for anchor group in case of shear loading perpendicular to free edge**

Configuration		with $c \geq$	with $s \geq$		
II: anchors placed parallel to horizontal joint		$C_{Cr}$	498	$\alpha_{g,V,II}$	[-]
I: anchors placed perpendicular to horizontal joint		$C_{Cr}$	238	$\alpha_{g,V,I}$	

**Table C31: Characteristic values of resistance under tension and shear loads**

Anchor size	Sleeve	Effective anchorage depth	Characteristic resistance						
			Use category						
			d/d			w/d			d/d
			40°C/24°C	80°C/50°C	120°C/72°C	40°C/24°C	80°C/50°C	120°C/72°C	w/d
		$h_{ef}$	$N_{Rk,b} = N_{Rk,p}^{1)}$			$N_{Rk,b} = N_{Rk,p}^{1)}$			For all temperature range
		[mm]	[kN]						
<b>Compressive strength <math>f_b \geq 10 \text{ N/mm}^2</math></b>									
M8	12x80	80	0,6	0,6	0,4	0,5	0,5	0,4	2,5
M8 / M10 / IG-M6	16x85	85	0,6	0,6	0,4	0,6	0,6	0,4	5,5
	16x130	130	2,5	2,5	2,0	2,5	2,5	2,0	5,5
M12 / M16 / IG-M8 / IG-M10	20x85	85	1,5	1,5	0,9	1,5	1,5	0,9	5,5
	20x130	130	2,5	2,5	2,0	2,5	2,5	2,0	5,5
<b>Compressive strength <math>f_b \geq 12 \text{ N/mm}^2</math></b>									
M8	12x80	80	0,75	0,6	0,5	0,6	0,6	0,4	3,0
M8 / M10 / IG-M6	16x85	85	0,75	0,6	0,5	0,75	0,6	0,5	6,5
	16x130	130	3,0	3,0	2,0	3,0	3,0	2,0	6,5
M12 / M16 / IG-M8 / IG-M10	20x85	85	1,5	1,5	1,2	1,5	1,5	1,2	6,5
	20x130	130	3,0	3,0	2,0	3,0	3,0	2,0	6,5

1) Values are valid for  $C_{Cr}$  and  $C_{min}$   
 2) Calculation of  $V_{Rk,c}$  see ETAG 029, Annex C, except for shear load parallel to free edge with  $c \geq 120 \text{ mm}$ :  $V_{Rk,c,II} = V_{Rk,b}$   
 3) The values are valid for steel 5.6 or greater. For steel 4.6 and 4.8 multiply  $V_{Rk,b}$  by 0,8

**EJOT Chemical Anchor MULTIFIX USF or MULTIFIX USF winter for masonry**

**Performances calcium hollow brick KS L-12DF**

Installation parameters (continue)

Characteristic values of resistance under tension and shear load

**Annex C 13**

**Brick type: Calcium silicate hollow brick KS L-12DF**

**Table C32: Characteristic values of resistance under tension and shear loads (continue)**

Anchor size	Sleeve	Effective anchorage depth	Characteristic resistance						
			Use category						
			d/d			w/d w/w			d/d w/d w/w
			40°C/24°C	80°C/50°C	120°C/72°C	40°C/24°C	80°C/50°C	120°C/72°C	For all temperature range
		$h_{ef}$	$N_{Rk,b} = N_{Rk,p}^{1)}$			$N_{Rk,b} = N_{Rk,p}^{1)}$			$V_{Rk,b}^{2)3)}$
		[mm]	[kN]						
<b>Compressive strength <math>f_b \geq 16 \text{ N/mm}^2</math></b>									
M8	12x80	80	0,9	0,9	0,6	0,75	0,75	0,5	3,5
M8 / M10 / IG-M6	16x85	85	0,9	0,9	0,6	0,9	0,9	0,6	8,0
	16x130	130	4,0	3,5	2,5	4,0	3,5	2,5	8,0
M12 / M16 / IG-M8 / IG-M10	20x85	85	2,0	2,0	1,5	2,0	2,0	1,5	8,0
	20x130	130	4,0	3,5	2,5	4,0	3,5	2,5	8,0

1) Values are valid for  $C_{cr}$  and  $C_{min}$

2) Calculation of  $V_{Rk,c}$  see ETAG 029, Annex C, except for shear load parallel to free edge with  $c \geq 120 \text{ mm}$ :  $V_{Rk,c,II} = V_{Rk,b}$

3) The values are valid for steel 5.6 or greater. For steel 4.6 and 4.8 multiply  $V_{Rk,b}$  by 0,8

**Table C33: Displacements**

Anchor size	Sleeve	Effective anchorage depth $h_{ef}$ [mm]	N [kN]	$\delta_N / N$ [mm/kN]	$\delta_{N0}$ [mm]	$\delta_{N\infty}$ [mm]	V [kN]	$\delta_{V0}$ [mm]	$\delta_{V\infty}$ [mm]
M8 / M10 / IG-M6	16x85	85	1,14	1,03	2,06				
	M12 / M16 / IG-M8 / IG-M10	16x130	130	0,57	0,51	1,03	2,3	2,5	3,75
20x85		85	1,14	1,03	2,06				
	20x130	130							

**EJOT Chemical Anchor MULTIFIX USF or MULTIFIX USF winter for masonry**

**Performances calcium hollow brick KS L-12DF**


Characteristic values of resistance under tension and shear load (continue)

Displacements

**Annex C 14**

**Brick type: Clay solid brick Mz-DF**


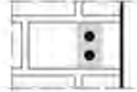
**Table C34: Description of the brick**

Brick type	Clay solid brick Mz-DF	
Bulk density $\rho$ [kg/dm <sup>3</sup> ]	1,6	
Compressive strength $f_b \geq$ [N/mm <sup>2</sup> ]	10, 20 or 28	
Code	EN 771-1	
Producer (country code)	e.g. Unipor (DE)	
Brick dimensions [mm]	240 x 115 x 55	
Drilling method	Hammer	

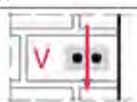

**Table C35: Installation parameter**

Anchor size		[-]	All sizes
Edge distance	$c_{cr}$	[mm]	$1,5 \cdot h_{ef}$
Minimum edge distance	$c_{min}$	[mm]	60
Spacing	$s_{cr}$	[mm]	$3 \cdot h_{ef}$
Minimum spacing	$s_{min}$	[mm]	120

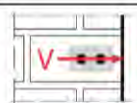

**Table C36: Group factor for anchor group in case of tension loading**

Configuration		with $c \geq$	with $s \geq$			
II: anchors placed parallel to horizontal joint		60	120	$\alpha_{g,N,II}$	[-]	0,7
		$1,5 \cdot h_{ef}$	$3 \cdot h_{ef}$			2,0
⊥: anchors placed perpendicular to horizontal joint		60	120	$\alpha_{g,N,I}$	[-]	0,5
		$1,5 \cdot h_{ef}$	120			1,0
		$1,5 \cdot h_{ef}$	$3 \cdot h_{ef}$			2,0

**Table C37: Group factor for anchor group in case of shear loading parallel to free edge**

Configuration		with $c \geq$	with $s \geq$			
II: anchors placed parallel to horizontal joint		60	120	$\alpha_{g,V,II}$	[-]	0,5
		90	120			1,1
		$1,5 \cdot h_{ef}$	$3 \cdot h_{ef}$			2,0
⊥: anchors placed perpendicular to horizontal joint		60	120	$\alpha_{g,V,I}$	[-]	0,5
		$1,5 \cdot h_{ef}$	120			1,0
		$1,5 \cdot h_{ef}$	$3 \cdot h_{ef}$			2,0

**Table C38: Group factor for anchor group in case of shear loading perpendicular to free edge**

Configuration		with $c \geq$	with $s \geq$			
II: anchors placed parallel to horizontal joint		60	120	$\alpha_{g,V,II}$	[-]	0,5
		$1,5 \cdot h_{ef}$	120			1,0
		$1,5 \cdot h_{ef}$	$3 \cdot h_{ef}$			2,0
⊥: anchors placed perpendicular to horizontal joint		60	120	$\alpha_{g,V,I}$	[-]	0,5
		$1,5 \cdot h_{ef}$	120			1,0
		$1,5 \cdot h_{ef}$	$3 \cdot h_{ef}$			2,0

**EJOT Chemical Anchor MULTIFIX USF or MULTIFIX USF winter for masonry**

**Performances clay solid brick Mz-DF**

Description of the brick  
Installation parameters

**Annex C 15**

**Brick type: Clay solid brick Mz-DF**

**Table C39: Characteristic values of resistance under tension and shear loads**

Anchor size	Sleeve	Effective anchorage depth	Characteristic resistance			
			Use category			
			d/d w/d w/w			d/d w/d w/w
			40°C/24°C	80°C/50°C	120°C/72°C	For all temperature range
$h_{ef}$		$N_{Rk,b} = N_{Rk,p}^{1)}$			$V_{Rk,b}^{2)3)}$	
[mm]		[kN]				
<b>Compressive strength <math>f_b \geq 10 \text{ N/mm}^2</math></b>						
M8	-	80	3,5 (1,5)	3,5 (1,5)	2,5 (1,2)	3,5 (1,2)
M10 / IG-M6	-	90	3,5 (1,5)	3,5 (1,5)	3,0 (1,5)	3,5 (1,2)
M12 / IG-M8	-	100	4,0 (2,0)	4,0 (2,0)	3,5 (1,5)	3,5 (1,2)
M16 / IG-M10	-	100	4,0 (2,0)	4,0 (2,0)	3,5 (1,5)	5,5 (1,5)
M8	12x80	80	3,5 (1,5)	3,5 (1,5)	3,0 (1,2)	3,5 (1,2)
M8 / M10 / IG-M6	16x85	85	3,5 (1,5)	3,5 (1,5)	3,0 (1,5)	3,5 (1,2)
	16x130	130	3,5 (1,5)	3,5 (1,5)	3,0 (1,5)	3,5 (1,2)
M12 / M16 / IG-M8 / IG-M10	20x85	85	3,5 (1,5)	3,5 (1,5)	3,0 (1,5)	3,5 (1,2)
	20x130	130	3,5 (1,5)	3,5 (1,5)	3,0 (1,5)	3,5 (1,2)
	20x200	200	3,5 (1,5)	3,5 (1,5)	3,0 (1,5)	3,5 (1,2)
<b>Compressive strength <math>f_b \geq 20 \text{ N/mm}^2</math></b>						
M8	-	80	4,5 (2,5)	4,5 (2,5)	4,0 (2,0)	5,0 (1,5)
M10 / IG-M6	-	90	5,5 (2,5)	5,5 (2,5)	4,5 (2,0)	5,0 (1,5)
M12 / IG-M8	-	100	6,0 (3,0)	6,0 (3,0)	5,0 (2,5)	5,0 (1,5)
M16 / IG-M10	-	100	6,0 (3,0)	6,0 (3,0)	5,0 (2,5)	8,0 (2,5)
M8	12x80	80	4,5 (2,5)	4,5 (2,5)	4,0 (2,0)	5,0 (1,5)
M8 / M10 / IG-M6	16x85	85	5,0 (2,5)	5,0 (2,5)	4,0 (2,0)	5,0 (1,5)
	16x130	130	5,0 (2,5)	5,0 (2,5)	4,0 (2,0)	5,0 (1,5)
M12 / M16 / IG-M8 / IG-M10	20x85	85	5,0 (2,5)	5,0 (2,5)	4,0 (2,0)	5,0 (1,5)
	20x130	130	5,0 (2,5)	5,0 (2,5)	4,0 (2,0)	5,0 (1,5)
	20x200	200	5,0 (2,5)	5,0 (2,5)	4,0 (2,0)	5,0 (1,5)
<b>Compressive strength <math>f_b \geq 28 \text{ N/mm}^2</math></b>						
M8	-	80	5,5 (2,5)	5,5 (2,5)	4,5 (2,5)	5,5 (2,0)
M10 / IG-M6	-	90	6,0 (3,0)	6,0 (3,0)	5,0 (2,5)	5,5 (2,0)
M12 / IG-M8	-	100	7,0 (3,5)	7,0 (3,5)	6,0 (3,0)	5,5 (2,0)
M16 / IG-M10	-	100	7,0 (3,5)	7,0 (3,5)	6,0 (3,0)	9,0 (3,0)
M8	12x80	80	5,5 (2,5)	5,5 (2,5)	4,5 (2,5)	5,5 (2,0)
M8 / M10 / IG-M6	16x85	85	6,0 (3,0)	6,0 (3,0)	5,0 (2,5)	5,5 (2,0)
	16x130	130	6,0 (3,0)	6,0 (3,0)	5,0 (2,5)	5,5 (2,0)
M12 / M16 / IG-M8 / IG-M10	20x85	85	6,0 (3,0)	6,0 (3,0)	5,0 (2,5)	5,5 (2,0)
	20x130	130	6,0 (3,0)	6,0 (3,0)	5,0 (2,5)	5,5 (2,0)
	20x200	200	6,0 (3,0)	6,0 (3,0)	5,0 (2,5)	5,5 (2,0)

1) Values are valid for  $c_{cr}$ , values in brackets are valid for single anchors with  $c_{min}$   
 2) For  $c_{cr}$  calculation of  $V_{Rk,c}$  see ETAG 029, Annex C; for  $c_{min}$  values in brackets  $V_{Rk,b} = V_{Rk,c}$   
 3) The values are valid for steel 5.6 or greater. For steel 4.6 and 4.8 multiply  $V_{Rk,b}$  by 0,8

**EJOT Chemical Anchor MULTIFIX USF or MULTIFIX USF winter for masonry**

**Performances clay solid brick Mz-DF**  
Characteristic values of resistance under tension and shear load

**Annex C 16**



**Brick type: Clay solid brick Mz-DF**

**Table C40: Displacements**

Anchor size	Sleeve	Effective anchorage depth $h_{ef}$	N	$\delta_N / N$	$\delta_{N0}$	$\delta_{N\infty}$	V	$\delta_{V0}$	$\delta_{V\infty}$
		[mm]	[kN]	[mm/kN]	[mm]	[mm]	[kN]	[mm]	[mm]
M8	-	80	1,3	0,15	0,19	0,39	1,9	1,00	1,50
M10 / IG-M6	-	90	1,6		0,24	0,47			
M12 / IG-M8	-	100	1,7		0,26	0,51			
M16 / IG-M10	-	100							
M8	12x80	80	1,3		0,19	0,39	1,9		
M8 / M10 / IG-M6	16x85	85							
	16x130	130							
M12 / M16 / IG-M8 / IG-M10	20x85	85							
	20x130	130							
	20x200	200							


**EJOT Chemical Anchor MULTIFIX USF or MULTIFIX USF winter for masonry**

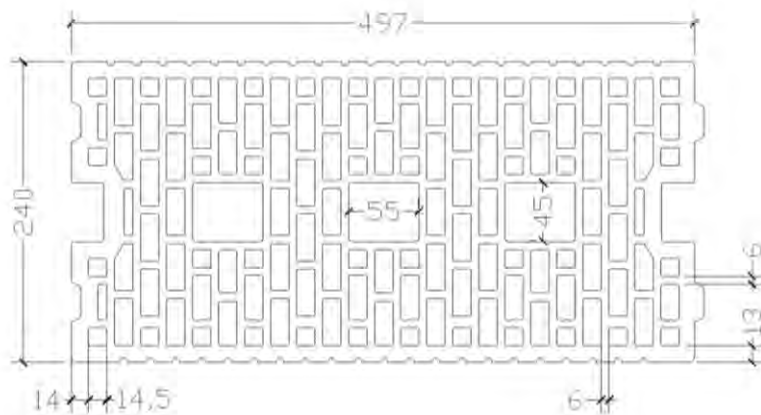
**Performances clay solid brick Mz-DF**  
Displacements

**Annex C 17**

**Brick type: Clay hollow brick HLz-16-DF**

**Table C41: Description of the brick**

Brick type	Clay hollow brick HLz-16-DF	
Bulk density $\rho$ [kg/dm <sup>3</sup> ]	0,8	
Compressive strength $f_b \geq$ [N/mm <sup>2</sup> ]	6, 8, 12, 14	
Code	EN 771-1	
Producer (country code)	e.g. Unipor DE	
Brick dimensions [mm]	497 x 240 x 238	
Drilling method	Rotary	




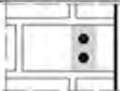
**Table C42: Installation parameters**

Anchor size		[-]	All sizes
Edge distance	$C_{cr}$	[mm]	100 (120) <sup>1)</sup>
Minimum edge distance	$C_{min}$ <sup>2)</sup>	[mm]	100 (120) <sup>1)</sup>
Spacing	$S_{cr,II}$	[mm]	497
	$S_{cr,I}$	[mm]	238
Minimum spacing	$S_{min}$	[mm]	100

<sup>1)</sup> Value in brackets for SH20x85; SH20x130 and SH20x200

<sup>2)</sup> For  $V_{Rk,c}$ :  $C_{min}$  according to ETAG 029, Annex C

**Table C43: Group factor for anchor group in case of tension loading**

Configuration		with $c \geq$	with $s \geq$			
II: anchors placed parallel to horizontal joint		$C_{cr}$	100	$\alpha_{g,N,II}$	[-]	1,3
		$C_{cr}$	497			2,0
I: anchors placed perpendicular to horizontal joint		$C_{cr}$	100	$\alpha_{g,N,I}$		1,1
		$C_{cr}$	238			2,0

**EJOT Chemical Anchor MULTIFIX USF or MULTIFIX USF winter for masonry**

**Performances clay hollow brick HLz-16DF**

Description of the brick  
Installation parameters

**Annex C 18**

**Brick type: Clay hollow brick HLz-16-DF**

**Table C44: Group factor for anchor group in case of shear loading parallel to free edge**

Configuration		with $c \geq$	with $s \geq$		
II: anchors placed parallel to horizontal joint		$C_{cr}$	497	$\alpha_{g,V,II}$	[-]
I: anchors placed perpendicular to horizontal joint		$C_{cr}$	238	$\alpha_{g,V,I}$	

**Table C45: Group factor for anchor group in case of shear loading perpendicular to free edge**

Configuration		with $c \geq$	with $s \geq$		
II: anchors placed parallel to horizontal joint		$C_{cr}$	497	$\alpha_{g,V,II}$	[-]
I: anchors placed perpendicular to horizontal joint		$C_{cr}$	238	$\alpha_{g,V,I}$	

**Table C46: Characteristic values of resistance under tension and shear loads**

Anchor size	Sleeve	Effective anchorage depth	Characteristic resistance			
			Use category			
			d/d w/d w/w			d/d w/d w/w
			40°C/24°C	80°C/50°C	120°C/72°C	For all temperature range
		$h_{ef}$	$N_{Rk,b} = N_{Rk,p}^{1)}$			$V_{Rk,b}^{2)3)}$
		[mm]	[kN]			
<b>Compressive strength <math>f_b \geq 6 \text{ N/mm}^2</math></b>						
M8	12x80	80	2,5	2,5	2,0	2,5
M8 / M10/ IG-M6	16x85	85	2,5	2,5	2,0	4,5
	16x130	130	3,5	3,5	3,0	4,5
M12 / M16 / IG-M8 / IG-M10	20x85	85	2,5	2,5	2,0	5,0
	20x130	130	3,5	3,5	3,0	6,0
	20x200	200	3,5	3,5	3,0	6,0
<b>Compressive strength <math>f_b \geq 8 \text{ N/mm}^2</math></b>						
M8	12x80	80	3,0	3,0	2,5	3,0
M8 / M10/ IG-M6	16x85	85	3,0	3,0	2,5	5,5
	16x130	130	4,5	4,5	3,5	5,5
M12 / M16 / IG-M8 / IG-M10	20x85	85	3,0	3,0	2,5	6,0
	20x130	130	4,5	4,5	3,5	7,0
	20x200	200	4,5	4,5	3,5	7,0

1) Values are valid for  $c_{cr}$  and  $c_{min}$

2) Calculation of  $V_{Rk,c}$  see ETAG 029, Annex C, except for shear load parallel to free edge with  $c \geq 125 \text{ mm}$ :  $V_{Rk,c,II} = V_{Rk,b}$

3) The values are valid for steel 5.6 or greater. For steel 4.6 and 4.8 multiply  $V_{Rk,b}$  by 0,8

**EJOT Chemical Anchor MULTIFIX USF or MULTIFIX USF winter for masonry**

**Performances clay hollow brick HLz-16DF**

Installation parameters (continue)

Characteristic values of resistance under tension and shear load

**Annex C 19**

**Brick type: Clay hollow brick HLz-16-DF**

**Table C47: Characteristic values of resistance under tension and shear loads (continue)**

Anchor size	Sleeve	Effective anchorage depth	Characteristic resistance			
			Use category			
			d/d w/d w/w			d/d w/d w/w
			40°C/24°C	80°C/50°C	120°C/72°C	For all temperature range
$h_{ef}$		$N_{Rk,b} = N_{Rk,p}^{1)}$			$V_{Rk,b}^{2)3)}$	
[mm]		[kN]				
<b>Compressive strength <math>f_b \geq 12 \text{ N/mm}^2</math></b>						
M8	12x80	80	3,5	3,5	3,0	4,0
M8 / M10/ IG-M6	16x85	85	3,5	3,5	3,0	6,5
	16x130	130	5,0	5,0	4,5	6,5
M12 / M16 / IG-M8 / IG-M10	20x85	85	3,5	3,5	3,0	7,0
	20x130	130	5,0	5,0	4,5	9,0
	20x200	200	5,0	5,0	4,5	9,0
<b>Compressive strength <math>f_b \geq 14 \text{ N/mm}^2</math></b>						
M8	12x80	80	4,0	4,0	3,0	4,0
M8 / M10/ IG-M6	16x85	85	4,0	4,0	3,0	6,5
	16x130	130	5,5	5,5	4,5	6,5
M12 / M16 / IG-M8 / IG-M10	20x85	85	4,0	4,0	3,0	7,0
	20x130	130	5,5	5,5	4,5	9,0
	20x200	200	5,5	5,5	4,5	9,0

1) Values are valid for  $c_{cr}$  and  $c_{min}$

2) Calculation of  $V_{Rk,c}$  see ETAG 029, Annex C, except for shear load parallel to free edge with  $c \geq 125 \text{ mm}$ :  $V_{Rk,c,II} = V_{Rk,b}$

3) The values are valid for steel 5.6 or greater. For steel 4.6 and 4.8 multiply  $V_{Rk,b}$  by 0,8

**Table C48: Displacements**

Anchor size	Sleeve	Effective anchorage depth $h_{ef}$	N	$\delta_N / N$	$\delta_{N0}$	$\delta_{N\infty}$	V	$\delta_{V0}$	$\delta_{V\infty}$
M8	12x80	80	1,14	0,10	0,11	0,23	1,10	1,20	1,80
M8 / M10/ IG-M6	16x85	85							
	16x130	130	1,57						
M12 / M16 / IG-M8 / IG-M10	20x85	85	1,14		0,11	0,23	1,86	1,50	2,25
	20x130	130	1,57		0,16	0,31	2,57	2,10	3,15
	20x200	200							

**EJOT Chemical Anchor MULTIFIX USF or MULTIFIX USF winter for masonry**


**Performances clay hollow brick HLz-16DF**

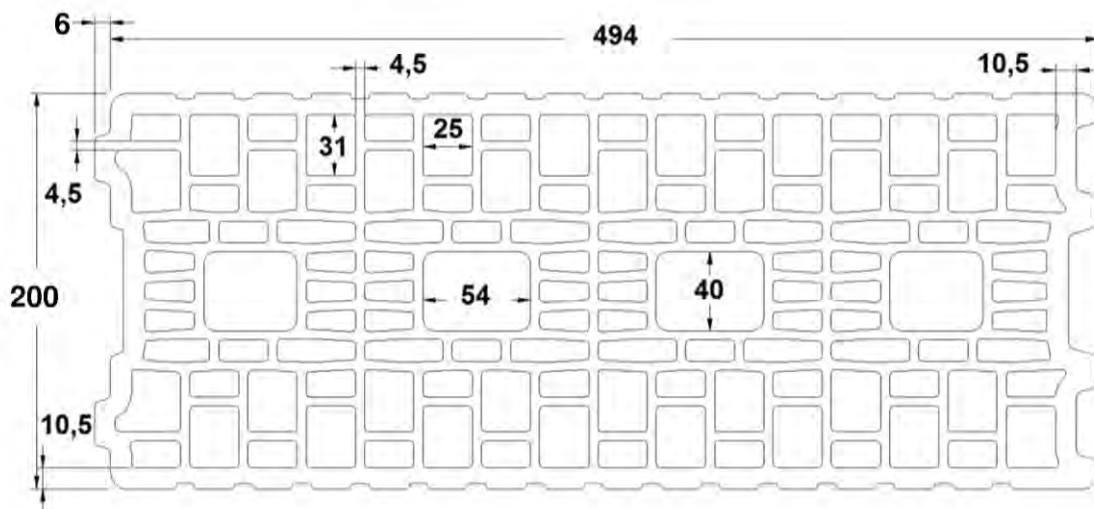
Characteristic values of resistance under tension and shear load (continue)  
Displacements

**Annex C 20**

**Brick type: Clay hollow brick Porotherm Homebric**

**Table C49: Description of the brick**

Brick type	Clay hollow hollow brick Porotherm Homebric	
Bulk density $\rho$ [kg/dm <sup>3</sup> ]	0,7	
Compressive strength $f_b \geq$ [N/mm <sup>2</sup> ]	4, 6 or 10	
Code	EN 771-1	
Producer (country code)	e.g. Wienerberger (FR)	
Brick dimensions [mm]	500 x 200 x 299	
Drilling method	Rotary	



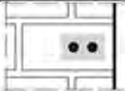
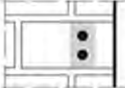
**Table C50: Installation parameters**

Anchor size		[-]	All sizes
Edge distance	$C_{cr}$	[mm]	100 (120) <sup>1)</sup>
Minimum edge distance	$C_{min}$ <sup>2)</sup>	[mm]	100 (120) <sup>1)</sup>
Spacing	$S_{cr,II}$	[mm]	500
	$S_{cr,\perp}$	[mm]	299
Minimum spacing	$S_{min}$	[mm]	100

<sup>1)</sup> Value in brackets for SH20x85 and SH20x130

<sup>2)</sup> For  $V_{Rk,c}$ :  $C_{min}$  according to ETAG 029, Annex C

**Table C51: Group factor for anchor group in case of tension loading**

Configuration		with $c \geq$	with $s \geq$			
II: anchors placed parallel to horizontal joint		200	100	$\alpha_{g,N,II}$	[-]	2,0
		$C_{cr}$	500			2,0
⊥: anchors placed perpendicular to horizontal joint		200	100	$\alpha_{g,N,\perp}$		1,2
		$C_{cr}$	299			2,0

**EJOT Chemical Anchor MULTIFIX USF or MULTIFIX USF winter for masonry**

**Performances clay hollow brick Porotherm Homebric**

Description of the brick  
Installation parameters

**Annex C 21**

**Brick type: Clay silicate hollow brick Porotherm Homebric**

**Table C52: Group factor for anchor group in case of shear loading parallel to free edge**

Configuration		with $c \geq$	with $s \geq$			
: anchors placed parallel to horizontal joint		$C_{Cr}$	500	$\alpha_{g,V,  }$	[-]	2,0
⊥: anchors placed perpendicular to horizontal joint		$C_{Cr}$	299	$\alpha_{g,V,\perp}$		2,0

**Table C53: Group factor for anchor group in case of shear loading perpendicular to free edge**

Configuration		with $c \geq$	with $s \geq$			
: anchors placed parallel to horizontal joint		$C_{Cr}$	500	$\alpha_{g,V,  }$	[-]	2,0
⊥: anchors placed perpendicular to horizontal joint		$C_{Cr}$	299	$\alpha_{g,V,\perp}$		2,0

**Table C54: Characteristic values of resistance under tension and shear loads**

Anchor size	Sleeve	Effective anchorage depth	Characteristic resistance			
			Use category			
			d/d w/d w/w			d/d w/d w/w
			40°C/24°C	80°C/50°C	120°C/72°C	For all temperature range
$h_{ef}$	$N_{Rk,b} = N_{Rk,p}^{1)}$			$V_{Rk,b}^{2)3)}$		
[mm]	[kN]					
<b>Compressive strength <math>f_b \geq 4 \text{ N/mm}^2</math></b>						
M8	12x80	80	0,9	0,9	0,75	2,0
M8 / M10/ IG-M6	16x85	85	0,9	0,9	0,75	2,0
	16x130	130	1,2	1,2	0,9	2,0
M12 / M16 / IG-M8 / IG-M10	20x85	85	0,9	0,9	0,75	2,5
	20x130	130	1,2	1,2	0,9	2,5
<b>Compressive strength <math>f_b \geq 6 \text{ N/mm}^2</math></b>						
M8	12x80	80	0,9	0,9	0,9	2,5
M8 / M10/ IG-M6	16x85	85	0,9	0,9	0,9	2,5
	16x130	130	1,2	1,2	1,2	2,5
M12 / M16 / IG-M8 / IG-M10	20x85	85	0,9	0,9	0,9	3,0
	20x130	130	1,2	1,2	1,2	3,0

1) Values are valid for  $C_{Cr}$  and  $C_{min}$

2) Calculation of  $V_{Rk,c}$  see ETAG 029, Annex C, except for shear load parallel to free edge with  $c \geq 200 \text{ mm}$ :  $V_{Rk,c,||} = V_{Rk,b}$

3) The values are valid for steel 5.6 or greater. For steel 4.6 and 4.8 multiply  $V_{Rk,b}$  by 0,8

**EJOT Chemical Anchor MULTIFIX USF or MULTIFIX USF winter for masonry**

**Performances clay hollow brick Porotherm Homebric**

Installation parameters (continue)

Characteristic values of resistance under tension and shear load

**Annex C 22**

**Brick type: Clay silicate hollow brick Porotherm Homebric**

**Table C55: Characteristic values of resistance under tension and shear loads (continue)**

Anchor size	Sleeve	Effective anchorage depth	Characteristic resistance			
			Use category			
			d/d w/d w/w			d/d w/d w/w
			40°C/24°C	80°C/50°C	120°C/72°C	For all temperature range
$h_{ef}$		$N_{Rk,b} = N_{Rk,p}^{1)}$			$V_{Rk,b}^{2)3)}$	
[mm]		[kN]				
<b>Compressive strength <math>f_b \geq 10 \text{ N/mm}^2</math></b>						
M8	12x80	80	1,2	1,2	1,2	3,0
M8 / M10/ IG-M6	16x85	85	1,2	1,2	1,2	3,0
	16x130	130	1,5	1,5	1,5	3,5
M12 / M16 / IG-M8 / IG-M10	20x85	85	1,2	1,2	1,2	4,0
	20x130	130	1,5	1,5	1,5	4,0

1) Values are valid for  $c_{cr}$  and  $c_{min}$

2) Calculation of  $V_{Rk,c}$  see ETAG 029, Annex C, except for shear load parallel to free edge with  $c \geq 200 \text{ mm}$ :  $V_{Rk,c,II} = V_{Rk,b}$

3) The values are valid for steel 5.6 or greater. For steel 4.6 and 4.8 multiply  $V_{Rk,b}$  by 0,8

**Table C56: Displacements**

Anchor size	Sleeve	Effective anchorage depth $h_{ef}$	N	$\delta_N / N$	$\delta_{N0}$	$\delta_{N\infty}$	V	$\delta_{V0}$	$\delta_{V\infty}$		
										[mm]	[kN]
M8	12x80	80	0,34	0,80	0,27	0,55	0,9	1,20	1,80		
M8 / M10/ IG-M6	16x85	85									
	16x130	130	0,43								
M12 / M16 / IG-M8 / IG-M10	20x85	85	0,34								
	20x130	130	0,43							0,34	0,69

**EJOT Chemical Anchor MULTIFIX USF or MULTIFIX USF winter for masonry**

**Performances clay hollow brick Porotherm Homebric**


Characteristic values of resistance under tension and shear load (continue)

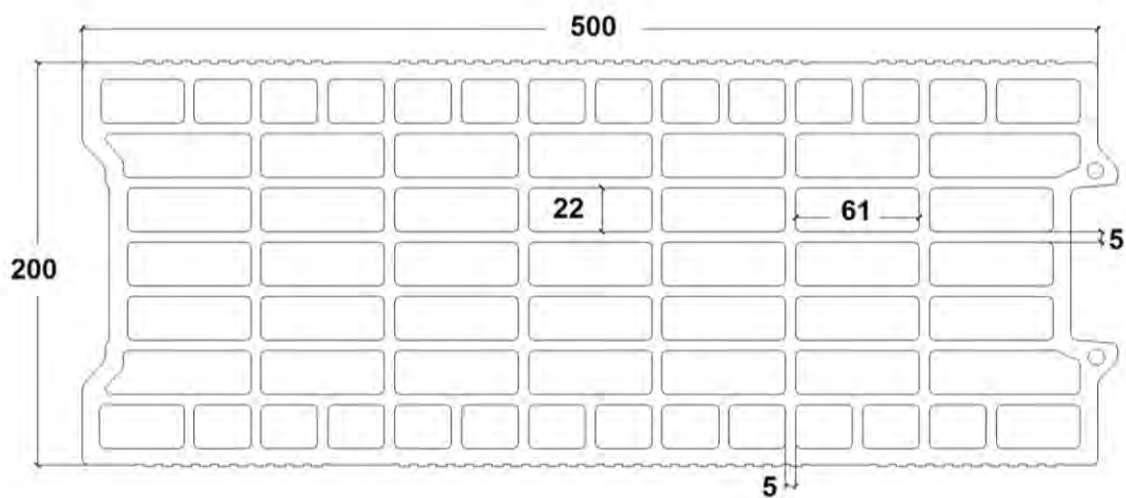
Displacements

**Annex C 23**

**Brick type: Clay hollow brick BGV Thermo**

**Table C57: Description of the brick**

Brick type	Clay hollow brick BGV Thermo	
Bulk density $\rho$ [kg/dm <sup>3</sup> ]	0,6	
Compressive strength $f_b \geq$ [N/mm <sup>2</sup> ]	4, 6 or 10	
Code	EN 771-1	
Producer (country code)	e.g. Leroux (FR)	
Brick dimensions [mm]	500 x 200 x 314	
Drilling method	Rotary	



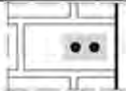
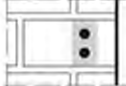
**Table C58: Installation parameters**

Anchor size		[-]	All sizes
Edge distance	$C_{cr}$	[mm]	100 (120) <sup>1)</sup>
Minimum edge distance	$C_{min}$ <sup>2)</sup>	[mm]	100 (120) <sup>1)</sup>
Spacing	$S_{cr,  }$	[mm]	500
	$S_{cr,\perp}$	[mm]	314
Minimum spacing	$S_{min}$	[mm]	100

<sup>1)</sup> Value in brackets for SH20x85 and SH20x130

<sup>2)</sup> For  $V_{Rk,c}$ :  $C_{min}$  according to ETAG 029, Annex C

**Table C59: Group factor for anchor group in case of tension loading**

Configuration		with $c \geq$	with $s \geq$			
: anchors placed parallel to horizontal joint		200	100	$\alpha_{g,N,  }$	[-]	1,7
		$C_{cr}$	500			2,0
⊥: anchors placed perpendicular to horizontal joint		200	100	$\alpha_{g,N,\perp}$		1,1
		$C_{cr}$	314			2,0

**EJOT Chemical Anchor MULTIFIX USF or MULTIFIX USF winter for masonry**

**Performances clay hollow brick BGV Thermo**

Description of the brick



Installation parameters

**Annex C 24**


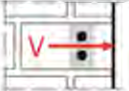


**Brick type: Clay hollow brick BGV Thermo**

**Table C60: Group factor for anchor group in case of shear loading parallel to free edge**

Configuration		with $c \geq$	with $s \geq$			
: anchors placed parallel to horizontal joint		$C_{gr}$	500	$\alpha_{g,V,  }$	[-]	2,0
⊥: anchors placed perpendicular to horizontal joint		$C_{gr}$	314	$\alpha_{g,V,\perp}$		2,0

**Table C61: Group factor for anchor group in case of shear loading perpendicular to free edge**

Configuration		with $c \geq$	with $s \geq$			
: anchors placed parallel to horizontal joint		$C_{gr}$	500	$\alpha_{g,V,  }$	[-]	2,0
⊥: anchors placed perpendicular to horizontal joint		$C_{gr}$	314	$\alpha_{g,V,\perp}$		2,0

**EJOT Chemical Anchor MULTIFIX USF or MULTIFIX USF winter for masonry**


**Performances clay hollow brick BGV Thermo**  
Installation parameters (continue)

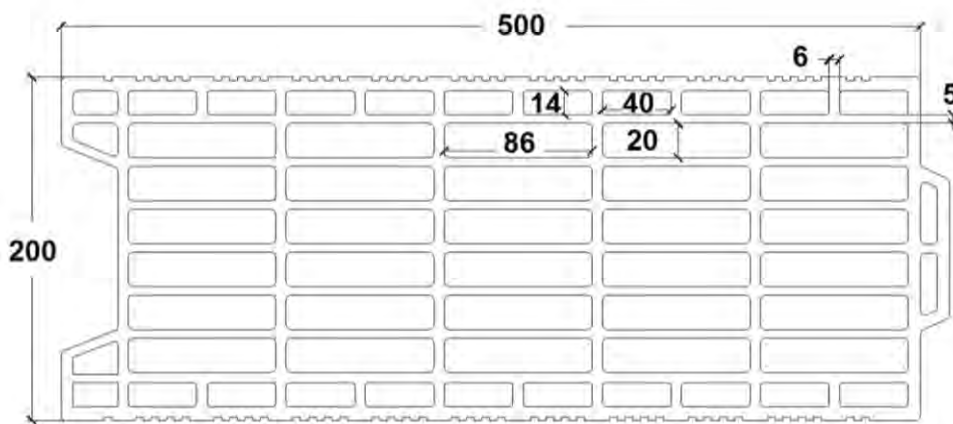
**Annex C 25**

<b>Brick type: Clay hollow brick BGV Thermo</b>									
<b>Table C62: Characteristic values of resistance under tension and shear loads</b>									
Anchor size	Sleeve	Effective anchorage depth	Characteristic resistance						
			Use category						
			d/d w/d w/w			d/d w/d w/w			
			40°C/24°C	80°C/50°C	120°C/72°C	For all temperature range			
$h_{ef}$		$N_{Rk,b} = N_{Rk,p}^{1)}$			$V_{Rk,b}^{2)3)}$				
[mm]		[kN]							
<b>Compressive strength <math>f_b \geq 4 \text{ N/mm}^2</math></b>									
M8	12x80	80	0,6	0,6	0,6	2,0			
M8 / M10/ IG-M6	16x85	85	0,6	0,6	0,6	2,0			
	16x130	130	1,2	1,2	0,9	2,5			
M12 / M16 / IG-M8 / IG-M10	20x85	85	0,6	0,6	0,6	2,5			
	20x130	130	1,2	1,2	0,9	2,5			
<b>Compressive strength <math>f_b \geq 6 \text{ N/mm}^2</math></b>									
M8	12x80	80	0,9	0,9	0,75	2,5			
M8 / M10/ IG-M6	16x85	85	0,9	0,9	0,75	2,5			
	16x130	130	1,5	1,5	1,2	3,0			
M12 / M16 / IG-M8 / IG-M10	20x85	85	0,9	0,9	0,75	3,0			
	20x130	130	1,5	1,5	1,2	3,0			
<b>Compressive strength <math>f_b \geq 10 \text{ N/mm}^2</math></b>									
M8	12x80	80	0,9	0,9	0,9	3,5			
M8 / M10/ IG-M6	16x85	85	0,9	0,9	0,9	3,5			
	16x130	130	2,0	2,0	1,5	4,0			
M12 / M16 / IG-M8 / IG-M10	20x85	85	0,9	0,9	0,9	4,0			
	20x130	130	2,0	2,0	1,5	4,0			
<sup>1)</sup> Values are valid for $c_{cr}$ and $c_{min}$ <sup>2)</sup> Calculation of $V_{Rk,c}$ see ETAG 029, Annex C, except for shear load parallel to free edge with $c \geq 250 \text{ mm}$ : $V_{Rk,c,II} = V_{Rk,b}$ <sup>3)</sup> The values are valid for steel 5.6 or greater. For steel 4.6 and 4.8 multiply $V_{Rk,b}$ by 0,8									
<b>Table C63: Displacements</b>									
Anchor size	Sleeve	Effective anchorage depth $h_{ef}$	N	$\delta_N / N$	$\delta_{N0}$	$\delta_{N\infty}$	V	$\delta_{V0}$	$\delta_{V\infty}$
		[mm]	[kN]	[mm/kN]	[mm]	[mm]	[kN]	[mm]	[mm]
M8	12x80	80	0,26	0,80	0,21	0,41	0,7	1,00	1,50
M8 / M10/ IG-M6	16x85	85							
	16x130	130	0,43		0,34	0,69			
M12 / M16 / IG-M8 / IG-M10	20x85	85	0,26		0,21	0,41	0,86		
	20x130	130	0,43	0,34	0,69				
<b>EJOT Chemical Anchor MULTIFIX USF or MULTIFIX USF winter for masonry</b>							<b>Annex C 26</b>		
<b>Performances clay hollow brick BGV Thermo</b>									
Characteristic values of resistance under tension and shear load Displacements									

**Brick type: Clay hollow brick Calibric R+**

**Table C64: Description of the brick**

Brick type	Clay hollow brick Calibric R+	
Bulk density $\rho$ [kg/dm <sup>3</sup> ]	0,6	
Compressive strength $f_b \geq$ [N/mm <sup>2</sup> ]	6, 9 or 12	
Code	EN 771-1	
Producer (country code)	e.g. Terreal (FR)	
Brick dimensions [mm]	500 x 200 x 314	
Drilling method	Rotary	



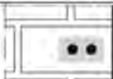
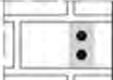
**Table C65: Installation parameters**

Anchor size		[-]	All sizes
Edge distance	$c_{cr}$	[mm]	100 (120) <sup>1)</sup>
Minimum edge distance	$c_{min}$ <sup>2)</sup>	[mm]	100 (120) <sup>1)</sup>
Spacing	$s_{cr,II}$	[mm]	500
	$s_{cr,I}$	[mm]	314
Minimum spacing	$s_{min}$	[mm]	100

<sup>1)</sup> Value in brackets for SH20x85 and SH20x130

<sup>2)</sup> For  $V_{Rk,c}$ :  $c_{min}$  according to ETAG 029, Annex C

**Table C66: Group factor for anchor group in case of tension loading**

Configuration		with $c \geq$	with $s \geq$			
II: anchors placed parallel to horizontal joint		175	100	$\alpha_{g,N,II}$	[-]	1,7
		$c_{cr}$	500			2,0
I: anchors placed perpendicular to horizontal joint		175	100	$\alpha_{g,N,I}$		1,0
		$c_{cr}$	314			2,0

**EJOT Chemical Anchor MULTIFIX USF or MULTIFIX USF winter for masonry**

**Performances clay hollow brick Calibric R+**

Description of the brick  
Installation parameters

**Annex C 27**

**Brick type: Clay hollow brick Calibric R+**

**Table C67: Group factor for anchor group in case of shear loading parallel to free edge**

Configuration		with $c \geq$	with $s \geq$			
: anchors placed parallel to horizontal joint		$C_{gr}$	500	$\alpha_{g,V,  }$	[-]	2,0
⊥: anchors placed perpendicular to horizontal joint		$C_{gr}$	314	$\alpha_{g,V,\perp}$		2,0

**Table C68: Group factor for anchor group in case of shear loading perpendicular to free edge**

Configuration		with $c \geq$	with $s \geq$			
: anchors placed parallel to horizontal joint		$C_{gr}$	500	$\alpha_{g,V,  }$	[-]	2,0
⊥: anchors placed perpendicular to horizontal joint		$C_{gr}$	314	$\alpha_{g,V,\perp}$		2,0

**Table C69: Characteristic values of resistance under tension and shear loads**

Anchor size	Sleeve	Effective anchorage depth	Characteristic resistance			
			Use category			
			d/d w/d w/w			d/d w/d w/w
			40°C/24°C	80°C/50°C	120°C/72°C	For all temperature range
		$h_{ef}$	$N_{Rk,b} = N_{Rk,d}^{1)}$			$V_{Rk,b}^{2)3)}$
		[mm]	[kN]			
<b>Compressive strength <math>f_b \geq 6 \text{ N/mm}^2</math></b>						
M8	12x80	80	0,9	0,9	0,75	3,0
M8 / M10/ IG-M6	16x85	85	0,9	0,9	0,75	4,0
	16x130	130	1,2	1,2	0,9	4,0
M12 / M16 / IG-M8 / IG-M10	20x85	85	0,9	0,9	0,75	6,0
	20x130	130	1,2	1,2	0,9	6,0
<b>Compressive strength <math>f_b \geq 9 \text{ N/mm}^2</math></b>						
M8	12x80	80	1,2	1,2	0,9	3,5
M8 / M10/ IG-M6	16x85	85	1,2	1,2	0,9	5,0
	16x130	130	1,5	1,5	1,2	5,0
M12 / M16 / IG-M8 / IG-M10	20x85	85	1,2	1,2	0,9	7,5
	20x130	130	1,5	1,5	1,2	7,5

1) Values are valid for  $c_{cr}$  and  $c_{min}$

2) Calculation of  $V_{Rk,c}$  see ETAG 029, Annex C, except for shear load parallel to free edge with  $c \geq 250 \text{ mm}$ :  $V_{Rk,c,||} = V_{Rk,b}$

3) The values are valid for steel 5.6 or greater. For steel 4.6 and 4.8 multiply  $V_{Rk,b}$  by 0,8

**EJOT Chemical Anchor MULTIFIX USF or MULTIFIX USF winter for masonry**

**Performances clay hollow brick Calibric R+**

Installation parameters (continue)

Characteristic values of resistance under tension and shear load

**Annex C 28**

**Brick type: Clay hollow brick Calibric R+**

**Table C70: Characteristic values of resistance under tension and shear loads (continue)**

Anchor size	Sleeve	Effective anchorage depth	Characteristic resistance			
			Use category			
			d/d w/d w/w			d/d w/d w/w
			40°C/24°C	80°C/50°C	120°C/72°C	For all temperature range
h <sub>ef</sub>		N <sub>Rk,b</sub> = N <sub>Rk,p</sub> <sup>1)</sup>			V <sub>Rk,b</sub> <sup>2)3)</sup>	
[mm]		[kN]				
<b>Compressive strength f<sub>b</sub> ≥ 12 N/mm<sup>2</sup></b>						
M8	12x80	80	1,2	1,2	0,9	4,0
M8 / M10/ IG-M6	16x85	85	1,2	1,2	0,9	5,5
	16x130	130	1,5	1,5	1,2	5,5
M12 / M16 / IG-M8 / IG-M10	20x85	85	1,2	1,2	0,9	8,5
	20x130	130	1,5	1,5	1,2	8,5

1) Values are valid for c<sub>cr</sub> and c<sub>min</sub>

2) Calculation of V<sub>Rk,c</sub> see ETAG 029, Annex C, except for shear load parallel to free edge with c ≥ 250 mm: V<sub>Rk,c,II</sub> = V<sub>Rk,b</sub>

3) The values are valid for steel 5.6 or greater. For steel 4.6 and 4.8 multiply V<sub>Rk,b</sub> by 0,8

**Table C71: Displacements**

Anchor size	Sleeve	Effective anchorage depth h <sub>ef</sub>	N	δ <sub>N</sub> / N	δ <sub>N0</sub>	δ <sub>N∞</sub>	V	δ <sub>V0</sub>	δ <sub>V∞</sub>
M8	12x80	80	0,34	0,80	0,27	0,55	1,0	1,10	1,65
M8 / M10/ IG-M6	16x85	85							
	16x130	130	0,43		0,34	0,69	1,43	2,00	3,00
M12 / M16 / IG-M8 / IG-M10	20x85	85	0,34		0,27	0,55	2,14		
	20x130	130	0,43		0,34	0,69			

**EJOT Chemical Anchor MULTIFIX USF or MULTIFIX USF winter for masonry**

**Performances clay hollow brick Calibric R+**


Characteristic values of resistance under tension and shear load (continue)

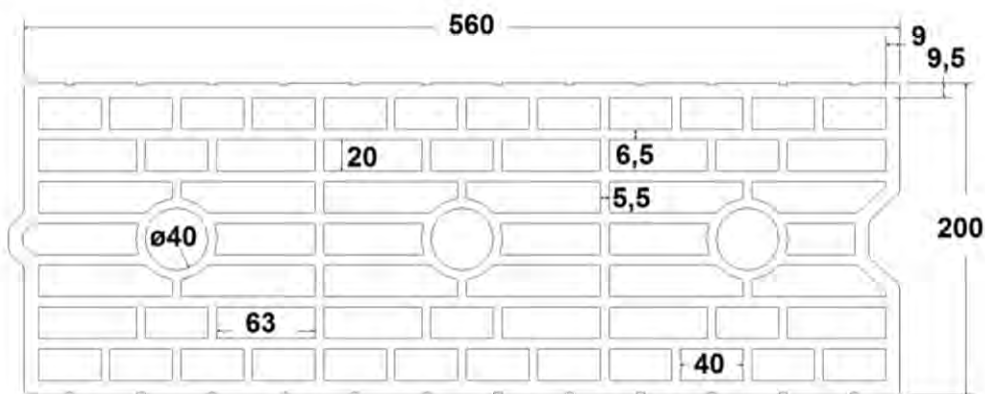
Displacements

**Annex C 29**

**Brick type: Clay hollow brick Urbanbric**

**Table C72: Description of the brick**

Brick type	Clay hollow brick Urbanbric	
Bulk density $\rho$ [kg/dm <sup>3</sup> ]	0,7	
Compressive strength $f_b \geq$ [N/mm <sup>2</sup> ]	6, 9 or 12	
Code	EN 771-1	
Producer (country code)	e.g. Imerys (FR)	
Brick dimensions [mm]	560 x 200 x 274	
Drilling method	Rotary	




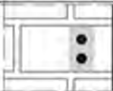
**Table C73: Installation parameters**

Anchor size		[-]	All sizes
Edge distance	$C_{cr}$	[mm]	100 (120) <sup>1)</sup>
Minimum edge distance	$C_{min}$ <sup>2)</sup>	[mm]	100 (120) <sup>1)</sup>
Spacing	$S_{cr,II}$	[mm]	560
	$S_{cr,\perp}$	[mm]	274
Minimum spacing	$S_{min}$	[mm]	100

<sup>1)</sup> Value in brackets for SH20x85 and SH20x130

<sup>2)</sup> For  $V_{Rk,c}$ :  $C_{min}$  according to ETAG 029, Annex C

**Table C74: Group factor for anchor group in case of tension loading**

Configuration		with $c \geq$	with $s \geq$	$\alpha_{g,N,II}$	[-]	
II: anchors placed parallel to horizontal joint		185	100			
		$C_{cr}$	560	2,0		
⊥: anchors placed perpendicular to horizontal joint		185	100	$\alpha_{g,N,\perp}$		1,1
		$C_{cr}$	274			2,0

**EJOT Chemical Anchor MULTIFIX USF or MULTIFIX USF winter for masonry**

**Performances clay hollow brick Urbanbric**

Description of the brick  
Installation parameters

**Annex C 30**

**Brick type: Clay hollow brick Urbanbric**

**Table C75: Group factor for anchor group in case of shear loading parallel to free edge**

Configuration		with $c \geq$	with $s \geq$		
II: anchors placed parallel to horizontal joint		$C_{cr}$	560	$\alpha_{g,V,II}$	[-]
I: anchors placed perpendicular to horizontal joint		$C_{cr}$	274	$\alpha_{g,V,I}$	

**Table C76: Group factor for anchor group in case of shear loading perpendicular to free edge**

Configuration		with $c \geq$	with $s \geq$		
II: anchors placed parallel to horizontal joint		$C_{cr}$	560	$\alpha_{g,V,II}$	[-]
I: anchors placed perpendicular to horizontal joint		$C_{cr}$	274	$\alpha_{g,V,I}$	

**Table C77: Characteristic values of resistance under tension and shear loads**

Anchor size	Sleeve	Effective anchorage depth	Characteristic resistance			
			Use category			
			d/d w/d w/w			d/d w/d w/w
			40°C/24°C	80°C/50°C	120°C/72°C	For all temperature range
		$h_{ef}$	$N_{Rk,b} = N_{Rk,p}^{1)}$			$V_{Rk,b}^{2)3)}$
		[mm]	[kN]			
<b>Compressive strength <math>f_b \geq 6 \text{ N/mm}^2</math></b>						
M8	12x80	80	0,9	0,9	0,75	3,0
M8 / M10/ IG-M6	16x85	85	0,9	0,9	0,75	3,0
	16x130	130	2,0	2,0	1,5	3,0
M12 / M16 / IG-M8 / IG-M10	20x85	85	0,9	0,9	0,75	3,5
	20x130	130	2,0	2,0	1,5	3,5
<b>Compressive strength <math>f_b \geq 9 \text{ N/mm}^2</math></b>						
M8	12x80	80	0,9	0,9	0,9	4,0
M8 / M10/ IG-M6	16x85	85	0,9	0,9	0,9	4,0
	16x130	130	2,5	2,5	2,0	4,0
M12 / M16 / IG-M8 / IG-M10	20x85	85	0,9	0,9	0,9	4,5
	20x130	130	2,5	2,5	2,0	4,5

1) Values are valid for  $C_{cr}$  and  $C_{min}$

2) Calculation of  $V_{Rk,c}$  see ETAG 029, Annex C, except for shear load parallel to free edge with  $c \geq 190 \text{ mm}$ :  $V_{Rk,c,II} = V_{Rk,b}$

3) The values are valid for steel 5.6 or greater. For steel 4.6 and 4.8 multiply  $V_{Rk,b}$  by 0,8

**EJOT Chemical Anchor MULTIFIX USF or MULTIFIX USF winter for masonry**

**Performances clay hollow brick Urbanbric**

Installation parameters (continue)

Characteristic values of resistance under tension and shear load

**Annex C 31**

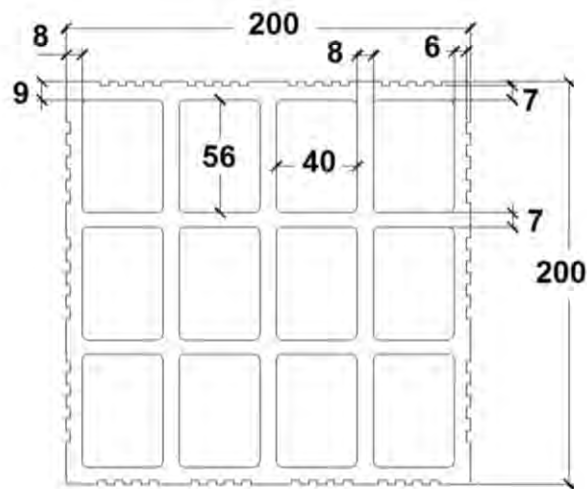
<b>Brick type: Clay hollow brick Urbanbric</b>									
<b>Table C78: Characteristic values of resistance under tension and shear loads (continue)</b>									
Anchor size	Sleeve	Effective anchorage depth	Characteristic resistance						
			Use category						
			d/d w/d w/w			d/d w/d w/w			
			40°C/24°C	80°C/50°C	120°C/72°C	For all temperature range			
		$h_{ef}$	$N_{Rk,b} = N_{Rk,p}^{1)}$			$V_{Rk,b}^{2)3)}$			
		[mm]	[kN]						
<b>Compressive strength <math>f_b \geq 12 \text{ N/mm}^2</math></b>									
M8	12x80	80	1,2	1,2	0,9	4,5			
M8 / M10/ IG-M6	16x85	85	1,2	1,2	0,9	4,5			
	16x130	130	3,0	3,0	2,5	4,5			
M12 / M16 / IG-M8 / IG-M10	20x85	85	1,2	1,2	0,9	5,0			
	20x130	130	3,0	3,0	2,5	5,0			
<sup>1)</sup> Values are valid for $c_{cr}$ and $c_{min}$ <sup>2)</sup> Calculation of $V_{Rk,c}$ see ETAG 029, Annex C, except for shear load parallel to free edge with $c \geq 190 \text{ mm}$ : $V_{Rk,c,II} = V_{Rk,b}$ <sup>3)</sup> The values are valid for steel 5.6 or greater. For steel 4.6 and 4.8 multiply $V_{Rk,b}$ by 0,8									
<b>Table C79: Displacements</b>									
Anchor size	Sleeve	Effective anchorage depth $h_{ef}$	N	$\delta_N / N$	$\delta_{N0}$	$\delta_{N\infty}$	V	$\delta_{V0}$	$\delta_{V\infty}$
		[mm]	[kN]	[mm/kN]	[mm]	[mm]	[kN]	[mm]	[mm]
M8	12x80	80	0,34	0,80	0,27	0,55	1,30	1,00	1,50
M8 / M10/ IG-M6	16x85	85			0,69	1,37			
	16x130	130	0,86		1,37				
M12 / M16 / IG-M8 / IG-M10	20x85	85	0,34		0,27	0,55	1,43		
	20x130	130	0,86	0,69	1,37				
<b>EJOT Chemical Anchor MULTIFIX USF or MULTIFIX USF winter for masonry</b>							<b>Annex C 32</b>		
<b>Performances clay hollow brick Urbanbric</b>									
Characteristic values of resistance under tension and shear load (continue) Displacements									



**Brick type: Clay hollow brick Brique creuse C40**

**Table C80: Description of the brick**

Brick type	Clay hollow brick Brique creuse C40
Bulk density $\rho$ [kg/dm <sup>3</sup> ]	0,7
Compressive strength $f_b \geq$ [N/mm <sup>2</sup> ]	4, 8 or 12
Code	EN 771-1
Producer (country code)	e.g. Terreal (FR)
Brick dimensions [mm]	500 x 200 x 200
Drilling method	Rotary



**Table C81: Installation parameters**

Anchor size		[-]	All sizes
Edge distance	$C_{cr}$	[mm]	100 (120) <sup>1)</sup>
Minimum edge distance	$C_{min}$ <sup>2)</sup>	[mm]	100 (120) <sup>1)</sup>
Spacing	$S_{cr,  }$	[mm]	500
	$S_{cr,\perp}$	[mm]	200
Minimum spacing	$S_{min}$	[mm]	200

<sup>1)</sup> Value in brackets for SH20x85 and SH20x130

<sup>2)</sup> For  $V_{Rk,c}$ :  $C_{min}$  according to ETAG 029, Annex C

**Table C82: Group factor for anchor group in case of tension loading**

Configuration		with $c \geq$	with $s \geq$			
: anchors placed parallel to horizontal joint		$C_{cr}$	200	$\alpha_{g,N,  }$	[-]	2,0
⊥: anchors placed perpendicular to horizontal joint		$C_{cr}$	200	$\alpha_{g,N,\perp}$		2,0

**EJOT Chemical Anchor MULTIFIX USF or MULTIFIX USF winter for masonry**

**Performances clay hollow brick Brique creuse C40**

Description of the brick  
Installation parameters

**Annex C 33**

**Brick type: Clay hollow brick Brique creuse C40**

**Table C83: Group factor for anchor group in case of shear loading parallel to free edge**

Configuration		with $c \geq$	with $s \geq$		
II: anchors placed parallel to horizontal joint		$C_{Cr}$	500	$\alpha_{g,V,II}$	[-]
I: anchors placed perpendicular to horizontal joint		$C_{Cr}$	200	$\alpha_{g,V,I}$	

**Table C84: Group factor for anchor group in case of shear loading perpendicular to free edge**

Configuration		with $c \geq$	with $s \geq$		
II: anchors placed parallel to horizontal joint		$C_{Cr}$	500	$\alpha_{g,V,II}$	[-]
I: anchors placed perpendicular to horizontal joint		$C_{Cr}$	200	$\alpha_{g,V,I}$	

**Table C85: Characteristic values of resistance under tension and shear loads**

Anchor size	Sleeve	Effective anchorage depth	Characteristic resistance			
			Use category			
			d/d w/d w/w			d/d w/d w/w
			40°C/24°C	80°C/50°C	120°C/72°C	For all temperature range
		$h_{ef}$ [mm]	$N_{Rk,b} = N_{Rk,p}$ <sup>1)</sup>			$V_{Rk,b}$ <sup>2)3)</sup>
			[kN]			
<b>Compressive strength <math>f_b \geq 4 \text{ N/mm}^2</math></b>						
M8	12x80	80	0,6	0,6	0,6	0,9
M8 / M10/ IG-M6	16x85	85	0,6	0,6	0,6	0,9
	16x130	130	0,6	0,6	0,6	0,9
M12 / M16 / IG-M8 / IG-M10	20x85	85	0,6	0,6	0,6	0,9
	20x130	130	0,6	0,6	0,6	0,9
<b>Compressive strength <math>f_b \geq 8 \text{ N/mm}^2</math></b>						
M8	12x80	80	0,9	0,9	0,75	1,2
M8 / M10/ IG-M6	16x85	85	0,9	0,9	0,75	1,2
	16x130	130	0,9	0,9	0,75	1,2
M12 / M16 / IG-M8 / IG-M10	20x85	85	0,9	0,9	0,75	1,2
	20x130	130	0,9	0,9	0,75	1,2

1) Values are valid for  $C_{Cr}$  and  $C_{min}$

2) Calculation of  $V_{Rk,c}$  see ETAG 029, Annex C

3) The values are valid for steel 5.6 or greater. For steel 4.6 and 4.8 multiply  $V_{Rk,b}$  by 0,8

**EJOT Chemical Anchor MULTIFIX USF or MULTIFIX USF winter for masonry**

**Performances clay hollow brick Brique creuse C40**

Installation parameters (continue)


Characteristic values of resistance under tension and shear load

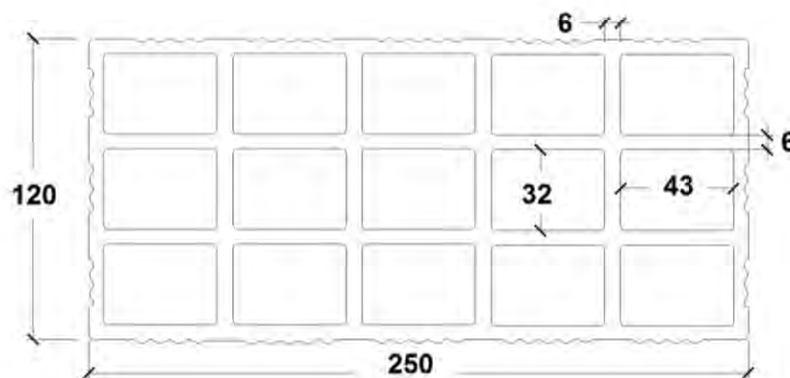
**Annex C 34**

<b>Brick type: Clay hollow brick Brique creuse C40</b>									
<b>Table C86: Characteristic values of resistance under tension and shear loads (continue)</b>									
Anchor size	Sleeve	Effective anchorage depth	Characteristic resistance						
			Use category						
			d/d w/d w/w			d/d w/d w/w			
			40°C/24°C	80°C/50°C	120°C/72°C	For all temperature range			
$h_{ef}$		$N_{Rk,b} = N_{Rk,p}^{1)}$			$V_{Rk,b}^{2)3)}$				
[mm]		[kN]							
<b>Compressive strength <math>f_b \geq 12 \text{ N/mm}^2</math></b>									
M8	12x80	80	1,2	1,2	0,9	1,5			
M8 / M10/ IG-M6	16x85	85	1,2	1,2	0,9	1,5			
	16x130	130	1,2	1,2	0,9	1,5			
M12 / M16 / IG-M8 / IG-M10	20x85	85	1,2	1,2	0,9	1,5			
	20x130	130	1,2	1,2	0,9	1,5			
<sup>1)</sup> Values are valid for $c_{cr}$ and $c_{min}$ <sup>2)</sup> Calculation of $V_{Rk,c}$ see ETAG 029, Annex C <sup>3)</sup> The values are valid for steel 5.6 or greater. For steel 4.6 and 4.8 multiply $V_{Rk,b}$ by 0,8									
<b>Table C87: Displacements</b>									
Anchor size	Sleeve	Effective anchorage depth $h_{ef}$	N	$\delta_N / N$	$\delta_{N0}$	$\delta_{N\infty}$	V	$\delta_{V0}$	$\delta_{V\infty}$
			[kN]	[mm/kN]	[mm]	[mm]	[kN]	[mm]	[mm]
M8	12x80	80	0,17	0,80	0,14	0,27	0,3	0,9	1,35
M8 / M10/ IG-M6	16x85	85							
	16x130	130							
M12 / M16 / IG-M8 / IG-M10	20x85	85							
	20x130	130							
<b>EJOT Chemical Anchor MULTIFIX USF or MULTIFIX USF winter for masonry</b>			<b>Annex C 35</b>						
<b>Performances clay hollow brick Brique creuse C40</b>									
Characteristic values of resistance under tension and shear load (continue) Displacements									

**Brick type: Clay hollow brick Blocchi Leggeri**

**Table C88: Description of the brick**

Brick type	Clay hollow brick Blocchi Leggeri	
Bulk density $\rho$ [kg/dm <sup>3</sup> ]	0,6	
Compressive strength $f_b \geq$ [N/mm <sup>2</sup> ]	4, 6, 8 or 12	
Code	EN 771-1	
Producer (country code)	e.g. Wienerberger (IT)	
Brick dimensions [mm]	250 x 120 x 250	
Drilling method	Rotary	


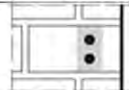


**Table C89: Installation parameters**

Anchor size		[-]	All sizes
Edge distance	$C_{cr}$	[mm]	100 (120) <sup>1)</sup>
Minimum edge distance	$C_{min}$	[mm]	60
Spacing	$S_{cr,II}$	[mm]	250
	$S_{cr,L}$	[mm]	120
Minimum spacing	$S_{min}$	[mm]	100

<sup>1)</sup> Value in brackets for SH20x85; SH20x130 and SH20x200

**Table C90: Group factor for anchor group in case of tension loading**

Configuration		with $c \geq$	with $s \geq$			
II: anchors placed parallel to horizontal joint		60	100	$\alpha_{g,N,II}$	[-]	1,0
		$C_{cr}$	250			2,0
I: anchors placed perpendicular to horizontal joint		60	100	$\alpha_{g,N,I}$		2,0

**EJOT Chemical Anchor MULTIFIX USF or MULTIFIX USF winter for masonry**

**Performances clay hollow brick Blocchi Leggeri**

Description of the brick  
Installation parameters


**Annex C 36**

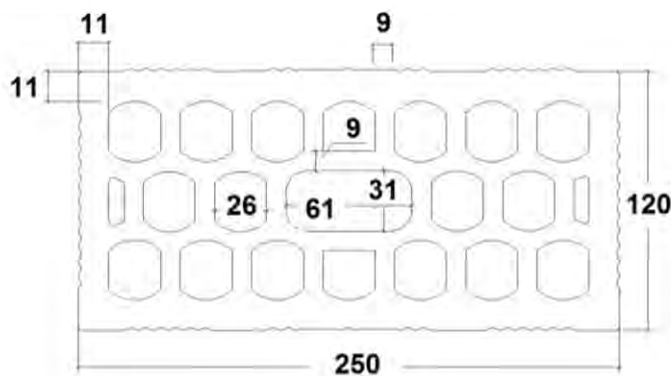
<b>Brick type: Clay hollow brick Blocchi Leggeri</b>						
<b>Table C91: Group factor for anchor group in case of shear loading parallel to free edge</b>						
Configuration		with $c \geq$	with $s \geq$			
II: anchors placed parallel to horizontal joint		$60^{1)}$	$100^{1)}$	$\alpha_{g,V,II}$	[-]	1,0
		$c_{cr}$	250			2,0
⊥: anchors placed perpendicular to horizontal joint		$60^{1)}$	$100^{1)}$	$\alpha_{g,V,\perp}$		1,6
		$c_{cr}$	250			2,0
<sup>1)</sup> Only valid for $V_{Rk,b}$ according to Table C93 and C94 values in brackets						
<b>Table C92: Group factor for anchor group in case of shear loading perpendicular to free edge</b>						
Configuration		with $c \geq$	with $s \geq$			
II: anchors placed parallel to horizontal joint		$60^{1)}$	$100^{1)}$	$\alpha_{g,V,II}$	[-]	1,0
		$c_{cr}$	250			2,0
⊥: anchors placed perpendicular to horizontal joint		$60^{1)}$	$100^{1)}$	$\alpha_{g,V,\perp}$		1,6
		$c_{cr}$	250			2,0
<sup>1)</sup> Only valid for $V_{Rk,b}$ according to Table C93 and C94 values in brackets						
<b>Table C93: Characteristic values of resistance under tension and shear loads</b>						
Anchor size	Sleeve	Effective anchorage depth	Characteristic resistance			
			Use category			
			d/d; w/d; w/w			
			40°C/24°C	80°C/50°C	120°C/72°C	For all temperature range
		$h_{ef}$	$N_{Rk,b} = N_{Rk,p}^{1)}$			$V_{Rk,b}^{4)}$
		[mm]	[kN]			
<b>Compressive strength <math>f_b \geq 4 \text{ N/mm}^2</math></b>						
M8	12x80	80	0,4	0,4	0,3	$2,0^{2)}$ ( $0,9^{3)}$
M8 / M10 / IG-M6	16x85	85				
	16x130	130				
M12 / M16 / IG-M8 / IG-M10	20x85	85				
	20x130	130				
	20x200	200				
<b>Compressive strength <math>f_b \geq 6 \text{ N/mm}^2</math></b>						
M8	12x80	80	0,5	0,5	0,4	$2,5^{2)}$ ( $1,2^{3)}$
M8 / M10 / IG-M6	16x85	85				
	16x130	130				
M12 / M16 / IG-M8 / IG-M10	20x85	85				
	20x130	130				
	20x200	200				
<sup>1)</sup> Values are valid for $c_{cr}$ and $c_{min}$ <sup>2)</sup> Calculation of $V_{Rk,c}$ see ETAG 029, Annex C, except for shear load parallel to free edge with $c \geq 125 \text{ mm}$ : $V_{Rk,c,II} = V_{Rk,b}$ <sup>3)</sup> Values in brackets $V_{Rk,c} = V_{Rk,b}$ for anchors with $c_{min}$ <sup>4)</sup> The values are valid for steel 5.6 or greater. For steel 4.6 and 4.8 multiply $V_{Rk,b}$ by 0,8						
<b>EJOT Chemical Anchor MULTIFIX USF or MULTIFIX USF winter for masonry</b>					<b>Annex C 37</b>	
<b>Performances clay hollow brick Blocchi Leggeri</b>						
Installation parameters (continue) Characteristic values of resistance under tension and shear load						

Brick type: Clay hollow brick Blocchi Leggeri									
Table C94: Characteristic values of resistance under tension and shear loads (continue)									
Anchor size	Sleeve	Effective anchorage depth	Characteristic resistance						
			Use category						
			d/d w/d w/w						
			40°C/24°C	80°C/50°C	120°C/72°C	For all temperature range			
$h_{ef}$		$N_{Rk,b} = N_{Rk,d}^{1)}$					$V_{Rk,b}^{4)}$		
[mm]		[kN]							
Compressive strength $f_b \geq 8 \text{ N/mm}^2$									
M8	12x80	80	0,6	0,6	0,5	3,0 <sup>2)</sup> (1,2) <sup>3)</sup>			
M8 / M10/ IG-M6	16x85	85							
	16x130	130							
M12 / M16 / IG-M8 / IG-M10	20x85	85							
	20x130	130							
	20x200	200							
Compressive strength $f_b \geq 12 \text{ N/mm}^2$									
M8	12x80	80	0,6	0,6	0,6	3,5 <sup>2)</sup> (1,5) <sup>3)</sup>			
M8 / M10/ IG-M6	16x85	85							
	16x130	130							
M12 / M16 / IG-M8 / IG-M10	20x85	85							
	20x130	130							
	20x200	200							
<sup>1)</sup> Values are valid for $c_{cr}$ and $c_{min}$ <sup>2)</sup> Calculation of $V_{Rk,c}$ see ETAG 029, Annex C, except for shear load parallel to free edge with $c \geq 125 \text{ mm}$ : $V_{Rk,c,II} = V_{Rk,b}$ <sup>3)</sup> Values in brackets $V_{Rk,c} = V_{Rk,b}$ for anchors with $c_{min}$ <sup>4)</sup> The values are valid for steel 5.6 or greater. For steel 4.6 and 4.8 multiply $V_{Rk,b}$ by 0,8									
Table C95: Displacements									
Anchor size	Sleeve	Effective anchorage depth $h_{ef}$	N	$\delta_N / N$	$\delta_{N0}$	$\delta_{N\infty}$	V	$\delta_{V0}$	$\delta_{V\infty}$
		[mm]	[kN]	[mm/kN]	[mm]	[mm]	[kN]	[mm]	[mm]
All sizes	All sizes	All sizes	0,17	1,20	0,21	0,41	0,9	1,20	1,80
<b>EJOT Chemical Anchor MULTIFIX USF or MULTIFIX USF winter for masonry</b>							<b>Annex C 38</b>		
<b>Performances clay hollow brick Blocchi Leggeri</b> Characteristic values of resistance under tension and shear load (continue) Displacements									

**Brick type: Clay hollow brick Doppio Uni**

**Table C96: Description of the brick**

Brick type	Clay hollow brick Doppio Uni	
Bulk density $\rho$ [kg/dm <sup>3</sup> ]	0,9	
Compressive strength $f_b \geq$ [N/mm <sup>2</sup> ]	10, 16, 20 or 28	
Code	EN 771-1	
Producer (country code)	e.g. Wienerberger (IT)	
Brick dimensions [mm]	250 x 120 x 120	
Drilling method	Rotary	



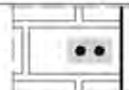

**Table C97: Installation parameters**

Anchor size		[-]	All sizes
Edge distance	$C_{cr}$	[mm]	100 (120) <sup>1)</sup>
Minimum edge distance	$C_{min}$ <sup>2)</sup>	[mm]	60
Spacing	$S_{cr,II}$	[mm]	250
	$S_{cr,\perp}$	[mm]	120
Minimum spacing	$S_{min,II}$	[mm]	100
	$S_{min,\perp}$	[mm]	120

<sup>1)</sup> Value in brackets for SH20x85; SH20x130 and SH20x200

<sup>2)</sup> For  $V_{Rk,c}$ :  $C_{min}$  according to ETAG 029, Annex C

**Table C98: Group factor for anchor group in case of tension loading**

Configuration		with $c \geq$	with $s \geq$			
II: anchors placed parallel to horizontal joint		60	100	$\alpha_{g,N,II}$	[-]	1,0
		$C_{cr}$	250			2,0
⊥: anchors placed perpendicular to horizontal joint		60	120	$\alpha_{g,N,\perp}$		2,0

**EJOT Chemical Anchor MULTIFIX USF or MULTIFIX USF winter for masonry**

**Performances clay hollow brick Doppio Uni**

Description of the brick  
Installation parameters

**Annex C 39**


<b>Brick type: Clay hollow brick Doppio Uni</b>						
<b>Table C99: Group factor for anchor group in case of shear loading parallel to free edge</b>						
Configuration		with $c \geq$	with $s \geq$			
: anchors placed parallel to horizontal joint		$c_{cr}$	250	$\alpha_{g,V,  }$	[-]	2,0
⊥: anchors placed perpendicular to horizontal joint		$c_{cr}$	120	$\alpha_{g,V,\perp}$		2,0
<b>Table C100: Group factor for anchor group in case of shear loading perpendicular to free edge</b>						
Configuration		with $c \geq$	with $s \geq$			
: anchors placed parallel to horizontal joint		$c_{cr}$	250	$\alpha_{g,V,  }$	[-]	2,0
⊥: anchors placed perpendicular to horizontal joint		$c_{cr}$	120	$\alpha_{g,V,\perp}$		2,0
<b>Table C101: Characteristic values of resistance under tension and shear loads</b>						
Anchor size	Sleeve	Effective anchorage depth	Characteristic resistance			
			Use category			
			d/d w/d w/w			
			40°C/24°C	80°C/50°C	120°C/72°C	For All temperature range
		$h_{ef}$	$N_{Rk,b} = N_{Rk,p}^{1)}$			$V_{Rk,b}^{2)3)}$
		[mm]	[kN]			
<b>Compressive strength <math>f_b \geq 10 \text{ N/mm}^2</math></b>						
M8	12x80	80	0,6	0,6	0,5	1,5
M8 / M10/ IG-M6	16x85	85				
	16x130	130				
M12 / M16 / IG-M8 / IG-M10	20x85	85				
	20x130	130				
	20x200	200				
<b>Compressive strength <math>f_b \geq 16 \text{ N/mm}^2</math></b>						
M8	12x80	80	0,75	0,75	0,6	2,0
M8 / M10/ IG-M6	16x85	85				
	16x130	130				
M12 / M16 / IG-M8 / IG-M10	20x85	85				
	20x130	130				
	20x200	200				
<sup>1)</sup> Values are valid for $c_{cr}$ and $c_{min}$ <sup>2)</sup> Calculation of $V_{Rk,c}$ see ETAG 029, Annex C <sup>3)</sup> The values are valid for steel 5.6 or greater. For steel 4.6 and 4.8 multiply $V_{Rk,b}$ by 0,8						
<b>EJOT Chemical Anchor MULTIFIX USF or MULTIFIX USF winter for masonry</b>					<b>Annex C 40</b>	
<b>Performances clay hollow brick Doppio Uni</b>						
Installation parameters (continue) Characteristic values of resistance under tension and shear load						

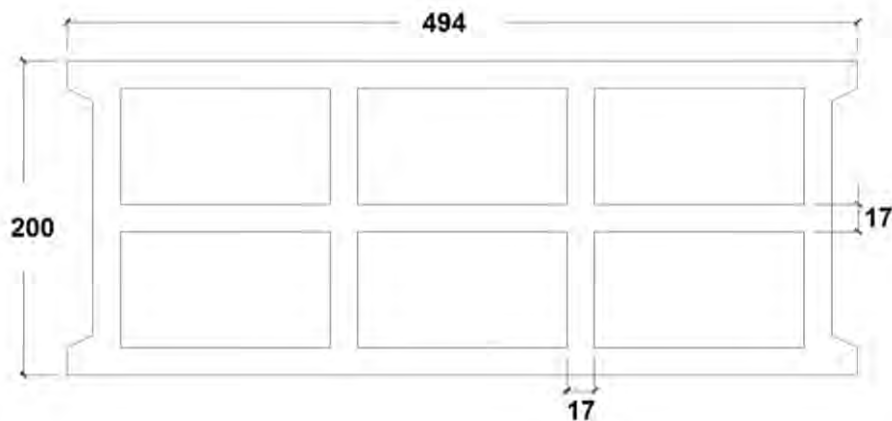


Brick type: Clay hollow brick Doppio Uni									
Table C102: Characteristic values of resistance under tension and shear loads (continue)									
Anchor size	Sleeve	Effective anchorage depth	Characteristic resistance						
			Use category						
			d/d w/d w/w						
			40°C/24°C	80°C/50°C	120°C/72°C	For All temperature range			
h <sub>ef</sub>		N <sub>Rk,b</sub> = N <sub>Rk,d</sub> <sup>1)</sup>					V <sub>Rk,b</sub> <sup>2)3)</sup>		
[mm]		[kN]							
Compressive strength f <sub>b</sub> ≥ 20 N/mm <sup>2</sup>									
M8	12x80	80	0,9	0,9	0,75	2,0			
M8 / M10/ IG-M6	16x85	85							
	16x130	130							
M12 / M16 / IG-M8 / IG-M10	20x85	85							
	20x130	130							
	20x200	200							
Compressive strength f <sub>b</sub> ≥ 28 N/mm <sup>2</sup>									
M8	12x80	80	1,2	1,2	0,9	2,5			
M8 / M10/ IG-M6	16x85	85							
	16x130	130							
M12 / M16 / IG-M8 / IG-M10	20x85	85							
	20x130	130							
	20x200	200							
<sup>1)</sup> Values are valid for c <sub>cr</sub> and c <sub>min</sub> <sup>2)</sup> Calculation of V <sub>Rk,c</sub> see ETAG 029, Annex C <sup>3)</sup> The values are valid for steel 5.6 or greater. For steel 4.6 and 4.8 multiply V <sub>Rk,b</sub> by 0,8									
Table C103: Displacements									
Anchor size	Sleeve	Effective anchorage depth h <sub>ef</sub>	N	δ <sub>N</sub> / N	δ <sub>N0</sub>	δ <sub>N∞</sub>	V	δ <sub>V0</sub>	δ <sub>V∞</sub>
		[mm]	[kN]	[mm/kN]	[mm]	[mm]	[kN]	[mm]	[mm]
All sizes	All sizes	All sizes	0,26	1,20	0,31	0,62	0,6	0,3	0,45
<b>EJOT Chemical Anchor MULTIFIX USF or MULTIFIX USF winter for masonry</b>							<b>Annex C 41</b>		
<b>Performances clay hollow brick Doppio Uni</b>									
Characteristic values of resistance under tension and shear load (continue) Displacements									

**Brick type: Hollow Light weight concrete Bloc creux B40**

**Table C104: Description of the brick**

Brick type	Hollow light weight concrete Bloc creux B40		
Bulk density $\rho$ [kg/dm <sup>3</sup> ]	0,8		
Compressive strength $f_b \geq$ [N/mm <sup>2</sup> ]	4		
Code	EN 771-3		
Producer (country code)	e.g. Sepa (FR)		
Brick dimensions [mm]	494 x 200 x 190		
Drilling method	Rotary		





**Table C105: Installation parameters**

Anchor size		[-]	All sizes
Edge distance	$c_{cr}$	[mm]	100 (120) <sup>1)</sup>
Minimum edge distance	$c_{min}$ <sup>2)</sup>	[mm]	100 (120) <sup>1)</sup>
Spacing	$s_{cr,  }$	[mm]	494
	$s_{cr,\perp}$	[mm]	190
Minimum spacing	$s_{min}$	[mm]	100

<sup>1)</sup> Value in brackets for SH20x85 and SH20x130

<sup>2)</sup> For  $V_{Rk,c}$ :  $c_{min}$  according to ETAG 029, Annex C

**Table C106: Group factor for anchor group in case of tension loading**

Configuration		with $c \geq$	with $s \geq$			
II: anchors placed parallel to horizontal joint		100	100	$\alpha_{g,N,II}$	[-]	1,5
		$c_{cr}$	494			2,0
⊥: anchors placed perpendicular to horizontal joint		100	100	$\alpha_{g,N,\perp}$	[-]	1,0
		$c_{cr}$	190			2,0

**EJOT Chemical Anchor MULTIFIX USF or MULTIFIX USF winter for masonry**

**Performances hollow light weight concrete Bloc creux B40**

Description of the brick  
Installation parameters

**Annex C 42**

**Brick type: Hollow Light weight concrete Bloc creux B40**

**Table C107: Group factor for anchor group in case of shear loading parallel to free edge**

Configuration		with $c \geq$	with $s \geq$			
II: anchors placed parallel to horizontal joint		50	100	$\alpha_{g,V,II}$	[-]	1,1
		$c_{cr}$	494			2,0
⊥: anchors placed perpendicular to horizontal joint		100	100	$\alpha_{g,V,\perp}$		1,1
		$c_{cr}$	190			2,0

**Table C108: Group factor for anchor group in case of shear loading perpendicular to free edge**

Configuration		with $c \geq$	with $s \geq$			
II: anchors placed parallel to horizontal joint		$c_{cr}$	494	$\alpha_{g,V,II}$	[-]	2,0
		⊥: anchors placed perpendicular to horizontal joint				$c_{cr}$

**Table C109: Characteristic values of resistance under tension and shear loads**

Anchor size	Sleeve	Effective anchorage depth	Characteristic resistance						
			Use category						
			d/d			w/d			d/d
			40°C/24°C	80°C/50°C	120°C/72°C	40°C/24°C	80°C/50°C	120°C/72°C	w/d
			$N_{Rk,b} = N_{Rk,p}^{1)}$			$N_{Rk,b} = N_{Rk,p}^{1)}$			For all temperature range
		$h_{ef}$	$V_{Rk,b}^{2)3)}$						
		[mm]	[kN]						
<b>Compressive strength <math>f_b \geq 4 \text{ N/mm}^2</math></b>									
M8	12x80	80	1,2	0,9	0,75	0,9	0,9	0,75	3,0
M8 / M10 / IG-M6	16x85	85	1,2	0,9	0,75	1,2	0,9	0,75	3,0
	16x130	130	1,2	0,9	0,75	1,2	0,9	0,75	3,0
M12 / M16 / IG-M8 / IG-M10	20x85	85	1,2	0,9	0,75	1,2	0,9	0,75	3,0
	20x130	130	1,2	0,9	0,75	1,2	0,9	0,75	3,0

1) Values are valid for  $c_{cr}$  and  $c_{min}$

2) Calculation of  $V_{Rk,c}$  see ETAG 029, Annex C, except for shear load parallel to free edge with  $c \geq 250 \text{ mm}$ :  $V_{Rk,c,II} = V_{Rk,b}$

3) The values are valid for steel 5.6 or greater. For steel 4.6 and 4.8 multiply  $V_{Rk,b}$  by 0,8

**Table C110: Displacements**

Anchor size	Sleeve	Effective anchorage depth $h_{ef}$	N	$\delta_N / N$	$\delta_{N0}$	$\delta_{N\infty}$	V	$\delta_{V0}$	$\delta_{V\infty}$
			[kN]	[mm/kN]	[mm]	[mm]	[kN]	[mm]	[mm]
All sizes	All sizes	All sizes	0,34	0,90	0,31	0,62	0,86	0,9	1,35

**EJOT Chemical Anchor MULTIFIX USF or MULTIFIX USF winter for masonry**

**Performances hollow light weight concrete brick Bloc creux B40**


Installation parameters (continue)

Characteristic values of resistance under tension and shear load / Displacements

**Annex C 43**

**Brick type: Solid light weight concrete brick - LAC**

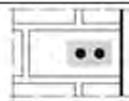
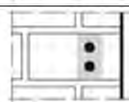
**Table C111: Description of the brick**

Brick type	Solid light weight concrete brick		
Bulk density $\rho$ [kg/dm <sup>3</sup> ]	0,6		
Compressive strength $f_b \geq$ [N/mm <sup>2</sup> ]	2		
Code	EN 771-3		
Producer (country code)	e.g. Bisotherm (DE)		
Brick dimensions [mm]	300 x 123 x 248		
Drilling method	Rotary		

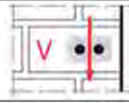

**Table C112: Installation parameter**

Anchor size		[-]	All sizes
Edge distance	$c_{cr}$	[mm]	$1,5 \cdot h_{ef}$
Minimum edge distance	$c_{min}$	[mm]	60
Spacing	$s_{cr}$	[mm]	$3 \cdot h_{ef}$
Minimum spacing	$s_{min}$	[mm]	120

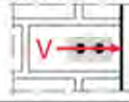
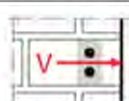
**Table C113: Group factor for anchor group in case of tension loading**

Configuration		with $c \geq$	with $s \geq$			
II: anchors placed parallel to horizontal joint		90	120	$\alpha_{g,N,II}$	[-]	1,1
		$1,5 \cdot h_{ef}$	$3 \cdot h_{ef}$			2,0
⊥: anchors placed perpendicular to horizontal joint		124	120	$\alpha_{g,N,\perp}$		1,1
		$1,5 \cdot h_{ef}$	$3 \cdot h_{ef}$			2,0

**Table C114: Group factor for anchor group in case of shear loading parallel to free edge**

Configuration		with $c \geq$	with $s \geq$			
II: anchors placed parallel to horizontal joint		60	120	$\alpha_{g,V,II}$	[-]	0,6
		90	120			2,0
⊥: anchors placed perpendicular to horizontal joint		60	120	$\alpha_{g,V,\perp}$		0,6
		124	120			2,0

**Table C115: Group factor for anchor group in case of shear loading perpendicular to free edge**

Configuration		with $c \geq$	with $s \geq$			
II: anchors placed parallel to horizontal joint		60	120	$\alpha_{g,V,II}$	[-]	0,6
		90	120			2,0
⊥: anchors placed perpendicular to horizontal joint		60	120	$\alpha_{g,V,\perp}$		0,6
		$1,5 \cdot h_{ef}$	120			1,0
		$1,5 \cdot h_{ef}$	$3 \cdot h_{ef}$		2,0	

**EJOT Chemical Anchor MULTIFIX USF or MULTIFIX USF winter for masonry**

**Performances solid light weight concrete brick - LAC**

Description of the brick  
Installation parameters

**Annex C 44**

**Brick type: Solid light weight concrete brick - LAC**

**Table C116: Characteristic values of resistance under tension and shear loads**

Anchor size	Sleeve	Effective anchorage depth	Characteristic resistance						
			Use category						
			d/d			w/d w/w			d/d w/d w/w
			40°C/24°C	80°C/50°C	120°C/72°C	40°C/24°C	80°C/50°C	120°C/72°C	For all temperature range
$h_{ef}$	$N_{Rk,b} = N_{Rk,p}^{1)}$			$N_{Rk,b} = N_{Rk,p}^{1)}$			$V_{Rk,b}^{2)3)}$		
[mm]	[kN]								
Compressive strength $f_b \geq 2 \text{ N/mm}^2$									
M8	-	80	3,0	2,5	2,0	2,5	2,0	1,5	3,0
M8 / M10/ IG-M6	-	90	3,0	3,0	2,0	2,5	2,5	2,0	3,0
M10 / IG-M8	-	100	3,5	3,0	2,5	3,0	2,5	2,0	3,0
M16 / IG-M10	-	100	3,0	3,0	2,0	3,0	3,0	2,0	3,0
M8	12x80	80	2,5	2,5	2,0	2,5	2,0	1,5	3,0
M8 / M10/ IG-M6	16x85	85	3,0	2,5	2,0	3,0	2,5	2,0	3,0
	16x130	130	3,0	2,5	2,0	3,0	2,5	2,0	3,0
M12 / M16 / IG-M8 / IG-M10	20x85	85	2,5	2,5	2,0	2,5	2,5	2,0	3,0
	20x130	130	2,5	2,5	2,0	2,5	2,5	2,0	3,0
	20x200	200	2,5	2,5	2,0	2,5	2,5	2,0	3,0

<sup>1)</sup> Values are valid for  $c_{Cr}$ , values in brackets are valid for single anchors with  $c_{min}$

<sup>2)</sup> For calculation of  $V_{Rk,c}$  see ETAG029, Annex C

<sup>3)</sup> The values are valid for steel 5.6 or greater. For steel 4.6 and 4.8 multiply  $V_{Rk,b}$  by 0,8

**Table C117: Displacements**

Anchor size	Sleeve	Effective anchorage depth $h_{ef}$	N	$\delta_N / N$	$\delta_{N0}$	$\delta_{N\infty}$	V	$\delta_{V0}$	$\delta_{V\infty}$
			[kN]	[mm/kN]	[mm]	[mm]	[kN]	[mm]	[mm]
M8	-	80	0,86	0,50	0,43	0,86	0,9	0,25	0,38
M8 / M10/ IG-M6	-	90							
M10 / IG-M8	-	100	1,00	0,35	0,35	0,70			
M16 / IG-M10	-	100							
M8	12x80	80	0,71	0,35	0,25	0,50			
M8 / M10/ IG-M6	16x85	85							
	16x130	130							
M12 / M16 / IG-M8 / IG-M10	20x85	85							
	20x130	130							
	20x200	200							

**EJOT Chemical Anchor MULTIFIX USF or MULTIFIX USF winter for masonry**

**Performances solid light weight concrete brick - LAC**  
Characteristic values of resistance under tension and shear load  
Displacements

**Annex C 45**